



MOTOROLA

MICOM-2E ALE HF-SSB Transceiver



Owner's Guide

68P02952C60-O

COMMERCIAL WARRANTY (STANDARD)

Motorola radio communications products are warranted to be free from defects in material and workmanship for a period of ONE (1) YEAR, (except for crystals and channel elements which are warranted for a period of ten (10) years), from the date of shipment. Parts, including crystals and channel elements, will be replaced free of charge for the full warranty period but the labor to replace defective parts will only be provided for One Hundred-Twenty (120) days from the date of shipment. Thereafter purchaser must pay for the labor involved in repairing the product or replacing the parts at the prevailing rates together with any transportation charges to or from the place where warranty service is provided. This express warranty is extended by Motorola Communications and Electronics Inc., 1301 E. Algonquin Road, Schaumburg, Illinois 60196, to the original purchaser only, and only to those purchasing for purpose of leasing or solely for commercial, industrial, or governmental use.

THIS WARRANTY IS GIVEN IN LIEU OF ALL OTHER WARRANTIES EXPRESS OR IMPLIED WHICH ARE SPECIFICALLY EXCLUDED, INCLUDING WARRANTIES OF MERCHANTABILITY OR FITNESS FOR A PARTICULAR PURPOSE. IN NO EVENT SHALL MOTOROLA BE LIABLE FOR INCIDENTAL OR CONSEQUENTIAL DAMAGES TO THE FULL EXTENT SUCH MAY BE DISCLAIMED BY LAW.

In the event of a defect, malfunction or failure to conform to specifications established by seller, or if appropriate, to specifications accepted by Seller in writing, during the period shown, Motorola, at its option, will either repair or replace the product or refund the purchase price thereof, and such action on the part of Motorola shall be the full extent of Motorola's liability hereunder.

This warranty is void if:

- a. the product is used in other than its normal and customary manner;
- b. the product has been subject to misuse, accident neglect or damage;
- c. unauthorized alterations or repairs have been made, or unapproved parts used in the equipment.

This warranty extends only to individual products, batteries are excluded, but carry their own separate limited warranty. Because each radio system is unique, Motorola disclaims liability for range, coverage, or operation of the system as a whole under this warranty except by a separate written agreement signed by an officer of Motorola.

Non-Motorola manufactured products are excluded from this warranty, but subject to the warranty provided by their manufacturers, a copy of which will be supplied to you on specific written request.

In order to obtain performance of this warranty, purchaser must contact its Motorola salesperson or Motorola at the address first above shown, attention Quality Assurance Department.

This warranty applies only within the United States.

COMPUTER SOFTWARE COPYRIGHTS

The Motorola products described in this instruction manual may include copyrighted Motorola computer programs stored in semiconductor memories or other media. Laws in the United States and other countries preserve for Motorola certain exclusive rights for copyrighted computer programs including the exclusive right to copy or reproduce in any form the copyrighted computer program. Accordingly, any copyrighted Motorola computer programs contained in the Motorola products described in this instruction manual may not be copied or reproduced in any manner without the express written permission of Motorola. Furthermore, the purchase of Motorola products shall not be deemed to grant either directly or by implication, estoppel, or otherwise, any license under the copyrights, patents or patent applications of Motorola, except for the normal non-exclusive, royalty free license to use that arises by operation of law in the sale of a product.



MOTOROLA

Land Mobile Products Sector

MICOM-2E ALE HF-SSB Transceiver

© Motorola Inc., 1997

Motorola, Inc.
Land Mobile Products Sector
1301 E. Algonquin Road
Schaumburg, IL 60196

Owner's Manual

68P02952C60-O
September, 1997

Table of Contents

<i>Glossary</i>	v
TECHNICAL SPECIFICATIONS	VII
GENERAL	VII
FCC INFORMATION	VIII
TRANSMITTER	IX
RECEIVER	X
MILITARY AND INDUSTRIAL STANDARDS	XI
INFORMATION FOR SAFE, EFFICIENT OPERATION	XIII
EXPOSURE TO RADIO FREQUENCY ENERGY	XIII
<i>Potentially Explosive Atmospheres</i>	<i>xiv</i>
<i>Blasting Caps and Areas</i>	<i>xiv</i>
GUIDELINES AND WARNINGS	XV
<i>Symbols</i>	<i>xv</i>
<i>Installation Safety Warning</i>	<i>xv</i>
<i>Operational Safety Warning</i>	<i>xv</i>
<i>Vehicles With an Air Bag</i>	<i>xvi</i>
<i>Restrictions</i>	<i>xvii</i>
INTRODUCTION	1
MICOM-2E HF-SSB RADIO FEATURES	1
MICOM-2E OPTIONS AND ACCESSORIES	2
TRANSMITTER FEATURES	2
RECEIVER FEATURES	3
FREQUENCY SOURCES	3
POWER SOURCE	3
CW KEYING OPERATION	3
PROGRAMMABLE FEATURES	4
OVERVIEW	5
TRANSCEIVER CONTROLS	5
LED INDICATORS	6
LCD DISPLAY	7
ICON INDICATORS	8
TRANSCEIVER REAR PANEL	9
ALERT TONE INDICATIONS	9

OPERATING INSTRUCTIONS..... 11

ACTIVATING THE RADIO 11

GLOBAL OPERATIONS 12

USING WORKING MODES 13

Working with Channel Mode 13

Working with Frequency Mode 17

Working in Scan Mode 20

Working in BITE Mode 21

Working in Lock Mode 22

Working in Program Mode 23

Working in Password Mode 24

Working in Transmit Mode 26

Checking the RF Power 26

Working in DIM Mode 27

PROGRAMMING THE RADIO..... 29

PROGRAMMING CHANNELS 30

Channel Options 30

Setting the Tx Power Level 33

Setting the Frequency 34

Choosing the Band Type 35

Setting the Operating Mode 36

Using Automatic Gain Control (AGC) 37

Setting the Band Width 38

SETTING RADIO PARAMETERS 39

Baud Rate (BAUD) 39

Data Power (DPWR) 40

Microphone Side Tone (MST) 41

Accessory Side Tone (AST) 41

PTT Release Beep (PTBP) 41

Keyboard Beep (KBBP) 42

Tone 42

Alternate Display Time-out (ADT) 43

SETTING RADIO OPTIONS 44

AUTOMATIC LINK ESTABLISHMENT (ALE)..... 45

ACTIVATING/DEACTIVATING THE ALE..... 46

LQA MEMORY..... 48

AUTOMATIC SOUNDING 48

Sounding Cycle Time..... 48

Immediate (Manual) Sounding..... 50

Optional Handshake/Call Reject..... 50

BI-DIRECTIONAL HANDSHAKE	51
ALE PROGRAMMING.....	51
RECEIVING CALLS.....	52
<i>Receiving an AllCall</i>	52
<i>Receiving an Individual Call</i>	53
<i>Receiving a Net Call</i>	54
<i>Receiving a Sound Call</i>	55
TRANSMITTING CALLS.....	56
<i>Transmitting AllCalls</i>	56
<i>Transmitting Individual Calls</i>	58
<i>Transmitting Net Calls</i>	60
LINK MODE.....	62
USING THE CALLER STACK.....	63
MONITORING THE SPEAKER.....	65
TUNING THE ANTENNA TUNER.....	66
INSTALLATION	67
GENERAL	67
<i>Government Regulations</i>	67
<i>Inspection</i>	67
<i>Radio Installation Planning</i>	67
BASE STATION INSTALLATION.....	68
FRONT MODEL INSTALLATION.....	69
TRUNK MODEL INSTALLATION.....	71
INSTALLATION PROCEDURES.....	73
<i>Mobile Mounting Kit</i>	73
<i>DC Power Connection</i>	73
<i>Microphone Clip</i>	76
<i>Final Connections</i>	76
<i>External Speaker Installation</i>	77
<i>Operational Checks</i>	78
CONNECTORS	79
<i>Microphone Connector J1</i>	79
<i>Antenna Connector J2</i>	79
<i>Accessory Connector J3</i>	79
<i>DC Connector J4</i>	81
VEHICULAR NOISE REDUCTION.....	82
MAINTENANCE.....	83
INTRODUCTION	83
BUILT-IN-TEST EQUIPMENT (BITE)	83
PREVENTIVE MAINTENANCE	83

System Integrity83
Periodic Calibration.....83
Using BITE84
TROUBLESHOOTING 85
SERVICE 87
 Radio Checks88
PROCEDURES..... 89

Index *Index-1*

Glossary

AGC	Automatic Gain Control
ALE	Automatic Link Establishment
AMD	Automatic Message Display
AME	Amplitude Modulation Equivalent
ARQ	Automatic Repeat Request
BITE	Built-In Test Equipment
CW	Continuous Wave
DSP	Digital Signal Processing
DTCXO	Digitally Temperature Controlled Crystal Oscillator
FEC	Forward Error Correction
FSK	Frequency Shift Keying
GND	Ground
HF	High Frequency
HSM	High Speed Modem
LED	Light Emitting Diode
LQA	Link Quality Analysis
LSB	Lower Side Band
LSM	Low Speed Modem
MCW	Modulated Continuous Wave
OCXO	Oven Controlled Crystal Oscillator
PEP	Peak Envelope Power
PLL	Phase Lock Loop
PTT	Push To Talk
RGK	Receiver Gain Control
RSS	Radio Service Software

RTTY	Radio Telex Teletype
SINAD	Signal to Signal Noise Distortion Ratio
SSB	Single Side Band
USB	Upper Side Band
VSWR	Voltage Standing Wave Ratio
XMIT	Transmit

Technical Specifications

General

Frequency Range		1.6 MHz to 30 MHz Tx, 100 kHz-30 MHz Rx
Number of Channels		200: User programmable; Simplex or Half Duplex
Scanning		5 groups with up to 100 channels per group
Frequency Stability		0.6 PPM, 0.1 PPM optional
Frequency Drift (Aging)		1 PPM per year
Synthesizer Lock Time		10 msec max.
Frequency Resolution		10 Hz
Audio Bandwidths @ -6dB		Voice: 350 to 2700 Hz CW: 650 to 1150 Hz Low speed data: 1450 to 1950 Hz High speed data: 350 to 3300 Hz
Operating Temperature Range		-30° to +60°C
Humidity		95% @ 50°C
Operating Voltage		13.8 V DC ±20% Neg. Ground
ALE		Per FED-STD 1045 and MIL-STD 188/141A
Current Drain @ 13.8 VDC		
Receive	Squelched	2.2A
	Full Audio	3A
Transmit	Voice	14A
	2 Tone	23A
	1 Tone	28A
Dimensions and Weights		
Front	Height (mm/inch)	92/3.7
	Width (mm/inch)	302/11.9
	Depth (mm/inch)	270/10.7
	Weight (Kg/pounds)	5.7/12.5

* Optional, for authorized users only.

Trunk Mount

Height (mm/inch)	92/3.7
Width (mm/inch)	302/11.9
Depth (mm/inch)	285/11.3
Weight (Kg/pounds)	5.9/13

Trunk Mount Control Head

Height (mm/inch)	60/2.36
Width (mm/inch)	187/7.36
Depth (mm/inch)	70/2.75
Weight (Kg/pounds)	0.32/0.71

FCC Information

Emissions	J3E, R3E, H3E, J2A, J2B
FCC Applicable Parts of Rules	15, 18, 90
FCC Type Acceptance Number	ABZ9QCC1635
With High Stability Option	ABZ9QCC1634

Transmitter

Output Power	125W P.E.P. and average
Reduced Power Levels	25W, 62W, 100W (RSS programmable)
Audio Bandwidth Ripple	3 dB
Intermodulation	-31 dB/P.E.P (-35 dB/P.E.P Typical. Note 1)
Harmonic Emissions	-64 dB/P.E.P (-70 dB/P.E.P Typical. Note 1)
Spurious Emissions	-64 dB/P.E.P (-70 dB/P.E.P Typical. Note 1)
Carrier Suppression	-50 dB/P.E.P
Undesired Sideband Suppression	-55 dB/P.E.P
Audio Distortion	2.5%
1/2 Power Mic. Sensitivity	25 to 125 mV (RMS)/600 Ohms
Hum & Ripple	-50 dB
Inband Noise	-60 dB (30 Hz BW)
TX/RX Switching Time	10 msec
Tx Tuning Adjustments	None

Receiver

Sensitivity (SINAD) SSB (Voice)	0.5 μ V for 10 dB SINAD (0.35 μ V Typical. Note 1) 0.1 - 1.6 MHz reduced performance
1/2 Rated Power Sensitivity	1 μ V for 2.5W audio @ speaker
Selectivity	-6 dB @ 350 to 2700 Hz -60 dB @ -1 kHz; +4 kHz
Image	-80 dB
IF	-85 dB
Undesired Sideband	-55 dB @ -1 kHz
Spurious	-80 dB
Intermodulation	-80 dB
Cross Modulation	-100 dB @ 100 kHz
Desensitization	-100 dB @ 100 kHz
Reciprocal Mixing	-100 dB @ 100 kHz
Audio Power @ Speaker	5W @ 2.5% distortion
RGC Range	5 μ V-1V (2 dB change in output level)
RGC Time Constants	
<i>Voice</i>	Attack time 10 msec Release time 1500 msec
<i>Data</i>	Attack time 10 msec Release time 10 msec
Squelch	Constant SINAD (digital)
Clarifier Range	\pm 200 Hz in 10 Hz steps
Receiver Tuning Adjustments	None
Preselector Sections	Sub-octave (1.6 MHz to 30 MHz range)
Maximum Antenna Input	20 kV maximum transient, 100V RMS for 2 minutes

Military and Industrial Standards

Vibration	US MIL-STD 810C	Method 514.2
	US MIL-STD 810D	514.3
	US MIL-STD 810E	514.4
Shock	US MIL-STD 810C	Method 516.2
	US MIL-STD 810D	516.3
	US MIL-STD 810E	516.4
Rain	US MIL-STD 810C	Method 506.1
	US MIL-STD 810D	506.2
	US MIL-STD 810E	506.3
Dust	US MIL-STD 810C	Method 510.1
	US MIL-STD 810D	510.2
	US MIL-STD 810E	510.3
Salt Fog	US MIL-STD 810C	Method 509.1
	US MIL-STD 810D	509.2
	US MIL-STD 810E	509.3

The MICOM-2E also meets the EIA-RS152B for shock, vibration and applicable test procedures, US FCC and Canadian DOC for channel occupancy, spurious, interference and frequency tolerance. It is manufactured according to the demanding standards of ISO 9000 and EMC (Electromagnetic Compatibility).

Note 1: Values noted as "Typical" are valid over 90% or more of the frequency range.

(blank)

Information for Safe, Efficient Operation

Exposure to Radio Frequency Energy

In August 1996, the Federal Communications Commission (FCC) adopted updated RF energy exposure guidelines for wireless products regulated by the FCC. Those guidelines are consistent with the safety standards* previously set by both U.S. and international standards bodies. The design of your Motorola two-way radio complies with the FCC guidelines and these standards.

*American National Standards Institute (C95.1 - 1992);

*National Council on Radiation Radiation Protection and Measurements (NCRP-1986);

*International Commission on Non-Ionizing Radiation Protection (ICNRP- 1986)

To assure optimal radio performance and to insure that exposure to RF energy is within the guidelines in the above standards, properly install antennas externally on the vehicle, following recommended installation procedures.

Transmit only when people inside or outside the vehicle are 1 to 3 feet away from the properly installed, externally mounted antenna; distance guidelines for the different power levels are summarized in the table below:

Rated power of Vehicle-Mounted Radio	Distance of people from Transmitting antenna
15 Watts or less	1 Foot
16 to 50Watts	2 Feet
More than 50Watts	3 Feet

Potentially Explosive Atmospheres



Turn your radio OFF when in any area with a potentially explosive atmosphere, unless it is a type especially qualified for such use (for example, FMRC Approved). Sparks in such areas could cause an explosion or fire resulting in bodily injury or even death.

Areas with potentially explosive atmospheres are often, but not always, clearly marked. They include fuelling areas such as below deck on boats, fuel or chemical transfer or storage facilities; areas where the air contains chemicals or particles, such as grain, dust, or metal powders; and any other area where you would normally be advised to turn off your vehicle engine.

Blasting Caps and Areas



To avoid possible interference with blasting operations, turn your radio OFF near electrical blasting caps or in a “blasting area” or in areas posted: “Turn off two-way radio”. Obey all signs and instructions.

Guidelines and Warnings

Symbols



The Warning symbol denotes a hazard. It calls attention to a procedure or practice that could result in personal injury if not performed correctly.



The Caution symbol denotes a hazard. It calls attention to a procedure or practice that could result in damage to or destruction of part or all of the product if not performed correctly.

Installation Safety Warning

Consider the occupants' safety when you choose a location for the radio. Do not mount the radio overhead or on a side wall unless you take special precautions.

If someone were to remove the radio and does not replace it properly, then a road block could bump the radio loose and the falling radio, could in some circumstances, cause serious injury to the driver or a passenger. In a crash, even when properly installed, the radio could break loose and become a dangerous projectile.

If you have to mount the radio overhead or on a sidewall, give it the added protection of a retaining strap.

Operational Safety Warning



For vehicles equipped with a electronic anti-skid systems, see "ANTI-SKID BRAKING PRECAUTIONS" publications, Motorola No. 68P81109E34.



It is mandatory that radio installation in vehicles fueled by liquefied petroleum gas conform to the following standard:

National Fire Protection Association standard NFPA 58 applies to radio installations in vehicles fueled by liquefied petroleum (LP) gas with LP gas container in the trunk or other sealed-off space within the interior of the vehicles. The standard requires that:

1. Any space containing radio equipment shall be isolated by a seal from the space in which the LP-gas container and its fittings are located.
2. Remote (outside) fitting connections shall be used.
3. The container space shall be vented to the outside.

Vehicles With an Air Bag



An air bag inflates with great force. Do not place objects, including portable or mobile two-way radios, in the area over the air bag or in the air bag deployment area. If improperly installed or placed wireless equipment is in the air bag deployment area and the air bag inflates, serious injury could result.

Installation of the MICOM-2E radio should be performed by a professional installer/technician qualified in the requirements for such installations. An air bag's size, shape and deployment area can vary by vehicle make, model and front compartment configuration (e.g., bench seat vs. bucket seat).

Contact the vehicle manufacturer's corporate headquarters, if necessary, for specific air bag information for the vehicle make, model and front compartment configuration involved in your communication equipment installation.

Restrictions

Because this radio contains a transmitter, federal law prohibits unauthorized, non-licensed personnel from adjusting or maintaining it. If any operational difficulties should arise while using this product, report them to authorized service personnel as soon as possible.



Do not attempt any unauthorized modification to the radio.

(blank)

Introduction

Welcome to the MICOM-2E HF-SSB radio family! Your choice of a MICOM-2E radio means you have selected the highest of standards in design, quality, and performance. This manual is design to acquaint you with the features, care, and installation of the MICOM-2E radio to better serve all your communication needs.

MICOM-2E HF-SSB Radio Features

The MICOM-2E has the following features:

- Digital Signal Processing (DSP)
- Built-in Test Equipment (BITE)
- RF power indicator
- 200 Channel capacity, simplex or half-duplex
- Channel scan or ALE
- Priority and guard channels
- Automatic IF shift
- Clarifier
- Excellent transmitter and receiver performance (as described herein)
- High frequency stability option
- Voice activated digital squelch
- Mil-Spec 810C, D and E performance

MICOM-2E Options and Accessories

- RS232 remote control interface
- Linear amplifier interface
- Phone patch interface
- Data/fax modem interface
- Interlink interface
- RSS for PC
- High (0.1 PPM) frequency stability
- Phone patch
- Interlink
- Desktop microphone
- Automatic antenna tuners
- Continuous duty data transmission kit
- AC power supply
- 1 kW amplifier
- Antennas and grounding
- Data/fax modems
- CW key and headphones
- External speaker

Transmitter Features

The maximum output power of the transmitter is 125 W PEP (Peak Envelope Power), with an average transmission duty cycle of 1 to 4, thus enabling even the CW (Continues Wave) signal to be transmitted at the maximum available power. Output power can be preprogrammed to one of the four possible levels: 25W, 62.5W, 100W and 125W. Accurate sensors are used to keep the output power within the nominal value.

The transmitter includes thermal protections. If, for any reason, the transmitter internal temperature exceeds the maximum permitted temperature, the output power is automatically reduced to avoid any fault due to excessive heat.

Mismatch protection is also included. If the VSWR (Voltage Standing Wave Ratio) rises to more than 2:1, the transmitter will be inhibited in order to avoid any damage and a message will be displayed.

Receiver Features

The radio utilizes Digital Signal Processing for implementing most of the reception functions like demodulations, narrow filtering, automatic gain control, noise blanking, and squelch.

The automatic digital noise blanker is activated whenever repetitive noise (e.g. ignition spikes) is encountered in the received signal. The digital syllabic (speech identifier) squelch is activated whenever speech is identified, thus opening the audio path. However, if speech is not received, the audio path is muted, thus preventing background noise from disturbing the operator.

Frequency Sources

Two types of frequency sources are available for the MICOM-2E radio. The standard 0.6 PPM DTCXO frequency source which assures a frequency stability of better than ± 18 Hz. For frequencies lower than 10 MHz, it assures a frequency stability of better than ± 6 Hz.

When higher frequency stability is required, the G478 0.1 PPM OCXO frequency source can be ordered. It will assure a frequency stability of better than ± 3 Hz at 30 MHz.

Power Source

The radio is designed for 13.8 V \pm 20% negative-ground operation and may be connected to a standard 12 V battery.

CW Keying Operation

When the CW key is pressed, the radio transmits a continuous wave (at the full programmed power) and stops transmission when the key is released.

CW keying operation is enabled by connecting the Morse key, between CW (pin #10) and ground (pin #18) at the accessory connector. If you wish to operate CW keying with external headphones, the S809 Interface can be used, thus enabling a standard PL55 headphone and standard PL99 Morse key to be connected to the accessories connector.

Programmable Features

The radio can be programmed using an IBM-PC and the Radio Service Software (RSS). Using this software, the radio can be preprogrammed for the following features:



- Up to 200 simplex/half duplex channels at SSB (J3E), AME (H3E), or Pilot (R3E) modes of transmission.
- Up to four levels of output power (up to 125W PEP and average).
- Five scanning groups of up to 200 channels, each with guard channel.

For further details, refer to *MICOM-2, HF-SSB Transceiver, RSS User's Guide*, Motorola Publication No. 68P02942C80.

Overview

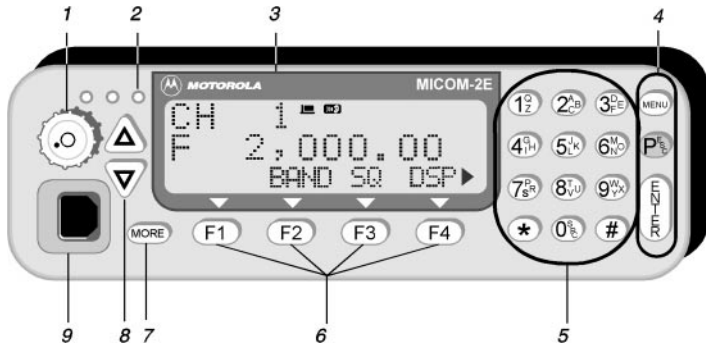
Transceiver Controls



No.	Name	Description
1.	ON/OFF VOLUME knob	
2.	TX LED indicator	A light that turns on when the radio is transmitting - see page 6.
3.	Display	The MICOM-2E has a three-line liquid-crystal display (LCD) that displays either alphanumeric messages or feature information.
4.	Mode function keys	Three keys that are used in entering and programming MICOM-2E:  Displays the main menu screens in the display.  Returns the display to the previous screen.  Confirms entries that you make in the working mode and registers them in MICOM-2E.

No.	Name	Description
5.	Keypad	A set of touchpad keys through which you enter numbers or alphabetical data entries into MICOM-2E.
6.	Function keys	Four function keys (F1, F2, F3, F4) whose functions change according to the working mode. The function that the function key defines appears above the function key in the LCD display in the third row of characters.
7.	MORE button	Scrolls to display additional menu options when a right arrow appears at the end of the options row (item 6 on page 7).
8.	UP/DOWN buttons	Scroll up/down the parameters of the mode displayed; e.g. in Channel mode, scroll the active channel numbers, in Frequency mode, change the offset frequency, etc.
9.	Microphone socket	Microphone and RSS cable input.

LED Indicators

The three LEDs, located on the left hand-side of the control head, indicate radio operating conditions.

LED	Color	Indicates
TX	Red	Transmission.
	Orange	Not used.
	Yellow	Not used.



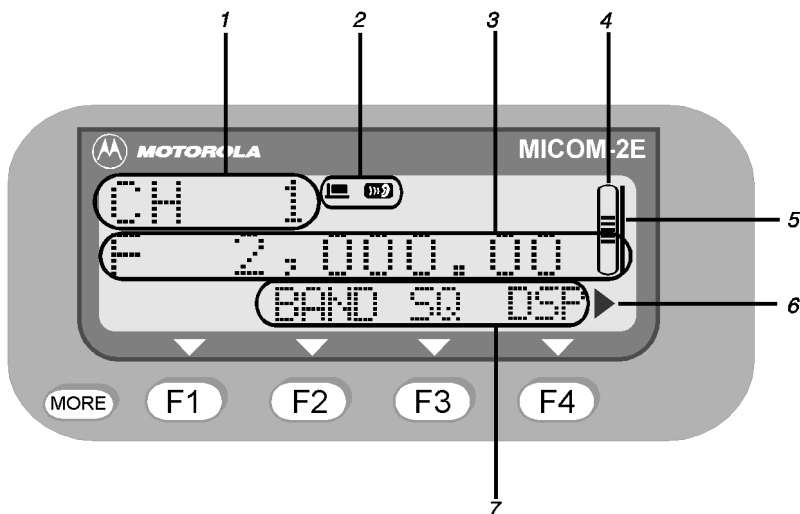







LCD Display



No.	Name	Description
1.	Mode indicator	Indicates the current working mode.
2.	Icon indicators	Indicate active parameters - see page 8.
3.	Mode information	Text that relates to the current operation in the current working mode.
4.	Rcv/Tx level	In Transmit mode, displays the output power level. In Receive mode, displays the received level.
5.	Tx bar	When PTT is pressed, this bar appears.
6.	More options icon	Press MORE when this arrow appears to see more menu options; its presence indicates that there are more options not displayed.
7.	Third row options	A list of options available in the current working mode.

Icon Indicators

Ten icons appear in the upper right area of the LCD display to indicate parameters that are active when you work with MICOM-2E.

Icon	Indicates
	Upper side band is active.
	Lower side band is active.
	Squelch is active.
	Monitoring is off.
	Noise blanker is active
	Clarify - frequency deviation is other than 0.
	Notch filter is active.
	Not standard band width filter.
	Fast Automatic Gain Control active.
	Page located in stack.

Transceiver Rear Panel

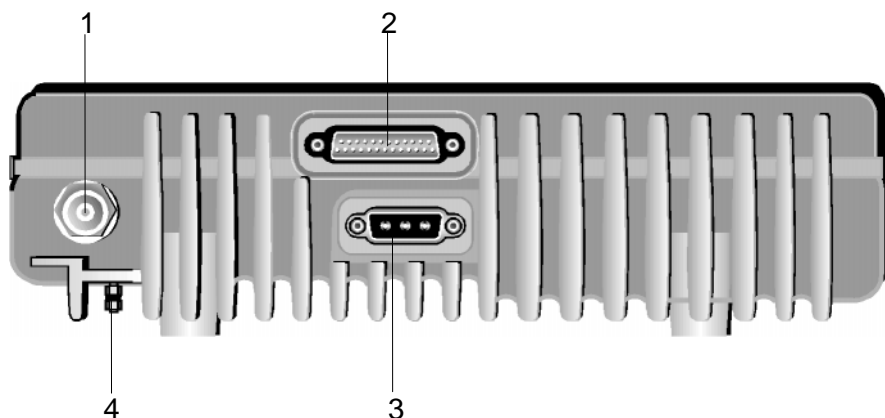

No.	Name	Description
1	Antenna socket	
2	Accessory connector (J3)	25-pin connector used to connect the radio to external accessories such as: personal computers, external modems, Morse key, etc.
3	DC connector (J4)	Power.
4	Ground screw	

Alert Tone Indications

The MICOM-2E generates some audible tones, enabled via the RSS or front panel programming, to indicate radio operating conditions. The intensity of the tone, low or high, may also be set using the RSS or by programming through the front panel.

Tone	Description
Valid key press:	A beep is sounded when a keypad key is pressed to indicate that the key was accepted.
PTT release:	A beep is sounded on the remote radio to indicate that the PTT button was released.

(blank)

Operating Instructions

Activating the Radio

To turn the radio on:

1. Turn the ON/OFF VOLUME knob clockwise until it clicks.

The display shows the words SELF TEST for about three seconds.

When the self test procedure is completed, the display enters the last operating mode: CH, ALE, SCAN, or FREQ.

If a self test fails, the display shows the word ERR and the number of one of the errors listed in Table 4 on page 84. The second line shows a short description of the error.



Global Operations

MICOM-2E assigns specific operations that are in effect in all working modes to six controls:



Used to turn the radio on and off and to control the volume.



Always used to scroll between values that are already programmed into MICOM-2E, whether they be channels or numerical values.



Always used to display the MICOM-2E main menu.



Cancels the last operation and returns to the previous screen.



Always confirms the selection and/or entered value and saves it in MICOM-2E.



Scrolls to menu options not displayed in the current screen. This button is active only when the right arrow ► appears at the end of the third row in the display.



Using Working Modes

The following sections describe how you use the various working modes in MICOM-2E.

Working with Channel Mode

The first menu option you see when you press  is Channel mode. Channel mode is used for choosing channels already programmed in MICOM-2E.

To enter Channel mode:

1. Press  to display the Menu screen.
2. Press  [CHAN].



Channel mode indicator

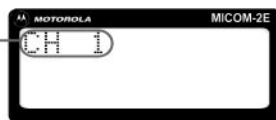

MICOM-2E blinks the last active channel in the display.

3. Press  to confirm your choice.

Once you are in Channel mode, the mode options appear in the LCD display:

- BAND - toggles between upper side band (USB) and lower side band (LSB).
- SQ - toggles the noise squelch on and off.
- DSP - displays the Digital Signal Processing menu. This menu includes submenus:
 - CLAR - Clarity mode



- NF - Notch filter
- CLIP - Clipper
- NB - Noise Blanker
- ATTN - Attenuator On/Off



- PWR - displays the Power Setting menu.



- MODE - displays the Mode menu.



- AGC - toggles the Automatic Gain Control.



- BW - displays the Band Width menu.



- RCLV - displays the receive level while **F1** is pressed.



When ALE is active, three additional options appear:

- [CALL] - initiates an ALE call (see pages 58-61).
- [PAGE] - displays stacked received messages (see page 63).
- [MON] - monitors the speaker (see page 65).

Choosing a New Channel

To choose a new channel:

1. In Channel mode, press the desired channel on the keypad.



If you enter a channel that has not already been programmed into MICOM-2E, you see a message indicating that the channel is not programmed. To read how to program a new channel into MICOM-2E, see the section entitled "Programming Channels" on page 30.



2. Press  to confirm your choice.

OR

Press  to browse among the programmed channels.

Example: you want to choose Channel 12. The last active channel was Channel 1.

Step 1 Enter Channel mode (if not in already).

Step 2 Press the digits "1" and "2" on the keypad so that the number "12" blinks in the LCD display.

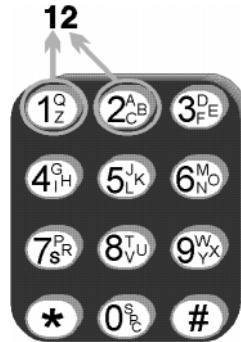



Step 3 Press  to confirm your choice.

If Channel 12 was not already programmed, you see an error message at this point. If it has already been programmed, the active channel is now 12.

Working with Frequency Mode

To enter Frequency mode:

1. Press  to display the Menu screen.
2. Press  [FREQ].
3. Press the function key beneath the frequency option of your choice (see the section entitled "Setting Frequencies" on page 19).
4. Press  to confirm your choice.



NOTE

Frequency mode is accessible only if the radio is not locked.

Once you are in Frequency mode, the mode options appear in the LCD display:

- T/R - sets the transmit and receive frequencies and frequency type.
- BAND - toggles between upper side band (USB) and lower side band (LSB).
- SQ - toggles the noise squelch on and off.
- DSP - displays the Digital Signal Processing menu (see pages 13-15 for submenus).
- PWR - displays the Power Tx Setting menu.
- MODE - displays the Mode menu.



- AGC - toggles Automatic Gain Control on/off.



- BW - displays the Band Width menu.



- RCLV - displays the receive level while **F1** is pressed.



- STOR - stores the frequency parameters in the channel.
- [-- -->] Set the scroll frequency digit.

When ALE is active, three additional options appear:

- [CALL] - initiates an ALE call (see pages 58-61).
- [PAGE] - displays stacked received messages (see page 63).
- [MON] - monitors the speaker (see page 66).

There are two ways to change the frequency.

To change the frequency value in the LCD display:

- A. 1. Press the function keys beneath the arrows to move the cursor to the digit in the frequency value that you want to change. The blinking digit indicates the cursor location.

2. Press  to scroll to the value of your choice.

- B. 1. Enter the value with the keypad.

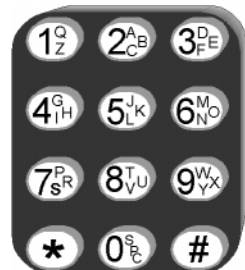

2. Press  to confirm your choice.

Setting Frequencies

MICOM-2E offers four frequency options:

- *Simplex Frequency (SMPX)* - transmits and receives on the same frequency.
- *Duplex Frequency (DPLX)* - transmits on one frequency and receives on a different frequency.
- *Receiving Only Frequency (RXO)* - defines a frequency for reception only.
- *Transmitting Only Frequency (TXO)* - defines a frequency for transmission only.

Working in Scan Mode

Scan mode is available only if ALE is turned off or not included.

In Scan mode, MICOM-2E surfs among the programmed channels. Up to five scan groups, A to E, may be created via the RSS, each containing up to 200 channels. When a guard channel is selected, it is monitored after every other scanned channel.

To enter Scan mode:

1. Press  to display the Menu screen.



2. Press  [SCAN].

MICOM-2E blinks the last active group.



3. Press the function key beneath the group you want to choose.

4. Press  to confirm your choice.

5. Once you are in Scan mode, the mode options appear in the LCD display:

- STOP/SCAN - toggles between activating the scan and stopping it.
- SLOW - decreases the scan speed.
- FAST - increases the scan speed.
- GRP - selects a scan group.



Working in BITE Mode

BITE mode is a testing mode that you use for maintaining MICOM-2E.

To enter BITE mode:

1. Press **MENU** to display the Menu screen.



2. Press **F4** [BIT].



Once you are in BITE mode, the mode options appear in the LCD display:

- **F1** [FULL] runs a full test of the hardware device.
- **F2** [CHAN] tests the device on the current channel.
- **F3** [L.RF] low RF; tests the reception path only.

See the section entitled “Built-In-Test Equipment (BITE)” on page 81 for more information regarding the use of this mode.

Working in Lock Mode

When you want to lock the radio to prevent others from changing the programming and frequency settings, you enter Lock mode to lock the radio with a password.

The default password that comes with MICOM-2E is 123456. The password contains up to six digits.

To enter Lock mode:

1. Press **MENU** to display the Menu screen.



2. Press **MORE** to scroll to the second Menu screen.



3. Press **F1** [LOCK].



4. Enter the password number to lock the radio.



5. Press **ENT** to confirm your choice.

Working in Program Mode

Program mode is the mode in which you program the parameters used in MICOM-2E.

NOTE

Program mode is accessible only if the radio is not locked.

To enter Program mode:

1. Press **MENU** to display the Menu screen.
2. Press **MORE** to scroll to the second Menu screen.
3. Press **F2** [PROG] to enter Program mode.
4. Press **F1** [RAD] to enter Radio Programming mode.



When you press **P_{ESC}** when in any option in Program mode, you return to the Radio Programming menu.

Refer to the chapter entitled “Programming the Radio” on page 29 for information regarding the use of Program mode.

Working in Password Mode

To be able to lock the radio, it is necessary to use a password. For security reasons, you may want to change the password often. You enter a password and make changes in Password mode.

To enter Password mode:

1. Press **MENU** to display the Menu screen.
2. Press **MORE** to scroll to the second Menu screen.
3. Press **F3** [PSW].



Setting a Password

MICOM-2E comes with the default password 123456 already programmed. To set a new password, in effect, you change the default password to a new password. See the following section for the procedure.

Changing a Password

To change the password:

1. Enter Password mode.



2. Enter the old password with the keypad.



You can use the function keys to move the cursor to the left or right or to clear the display to start over, as shown in the display when you start to enter the password.

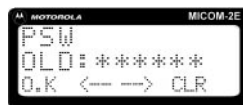

3. Press **F1** [O.K.] after you enter the old password.

If you enter the wrong password, MICOM-2E displays an error message.

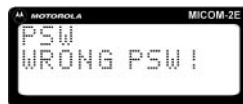

4. Enter the new password with the keypad.



5. Press **F1** [O.K.] to confirm the new password.



Working in Transmit Mode

NOTE

Before transmitting, ensure that the RF output of the radio is connected to a tuned antenna or to a dummy load.

To transmit:

1. Press and hold down the Push-to-Talk (PTT) button on the side of the microphone and speak slowly and clearly after the channel is clear.

The TX LED will remain lit until the PTT button is released to indicate that you are “on-the-air”.

Checking the RF Power

When you press the PTT button, you will see on the display:

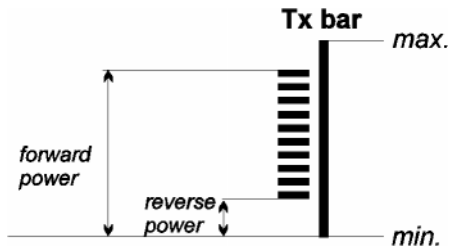

The received filter changes according to PTT activity.

Filter set to:

<i>CW filter</i>	After first CW PTT
<i>LSM filter</i>	After first data PTT and only if the filter channel is programmed to LSM filter.
<i>Voice filter</i>	After microphone PTT or voice PTT.
<i>HSM filter</i>	After first data PTT and only if the filter channel is programmed to HSM filter.

Working in DIM Mode

DIM mode controls the brightness of the display.

To enter DIM mode:

1. Press **MENU** to display the Menu screen.
2. Press **MORE** to scroll to the second Menu screen.
3. Press **F4** to scroll the dimmer.



MICOM-2E offers four levels of display brightness, ranging from DIM Level 0 (dimmiest) to DIM Level 3 (brightest).

To change the display brightness level:

1. Enter the DIM menu.
2. Press **F4** repeatedly until you reach the desired brightness level.

(blank)

Programming the Radio

MICOM-2E is already configured for use at the time of purchase. However, at times, it is necessary to change the configuration. The following sections relate to MICOM-2E's Programming mode.

You can find your radio parameter and change it by pressing a function key under the parameter name, or you can press → the scroll arrow keys to scroll through the parameters.

To enter Programming mode:

1. Press **MENU** to display the Menu screen.
2. Press **MORE** to scroll to the second Menu screen.
3. Press **F2** [PROG] to enter Program mode.
4. Press **F1** [RAD] to enter Radio Programming mode.



In this menu, you program:

- channels
- radio parameters
- radio options

The following sections explain the programming procedures in detail.

Programming Channels

When you choose the CHAN option in the Radio Programming menu, you see a menu with the following options:

- GET - Get programmed channel
- STOR - Store channel
- ERAS - Erase programmed channel
- PWR - Tx power level
- FREQ - Frequency
- BAND - Band type
- MODE - Radio mode
- AGC - Automatic Gain Control
- BW - Band width

The use of each option is explained in the following sections.

Channel Options

The first three options, GET, STOR, and ERAS, are used for programming channels in MICOM-2E.

GET retrieves channels already programmed in MICOM-2E. Once a channel is programmed in MICOM-2E, it is stored with all its parameters. Retrieving a channel retrieves all the parameters defined for the channel.

To copy a channel's parameters to another channel:

1. Enter the Radio Programming menu (steps 1-4 on page 29).



2. Press **F1** [CHAN].



3. Press **F1** [GET].



4. Enter the number of the channel to which you want to copy the parameters with the keypad.



5. Select the source channel.

6. Press **F2** [STOR].



Note that the channel number is flashing, which indicates that you can change it or leave it at the current number.

7. Enter the number of the channel to which you want to copy the parameters with the keypad.



If you need to backspace, press **F3** [BACK].

If you want to clear the display, press **F4** [CLR].

8. Press **ENT** to confirm.

To delete a channel from MICOM-2E:

1. Enter the Radio Programming menu (steps 1-4 on page 29).



2. Press **F1** [CHAN].



3. Press **F3** [ERAS].



4. Enter the number of the channel to which you want to delete.



If you need to backspace, press **F3** [BACK].

If you want to clear the display, press **F4** [CLR].

5. Press **ENT** to confirm.

Setting the Tx Power Level

Four power levels are possible for a programmed channel:

- LOW
- MED
- HIGH
- MAX

To set the channel's Tx power level:

1. Enter the Radio Programming menu (steps 1-4 on page 29).

2. Press **F1** [CHAN].



3. Press **F4** [PWR].

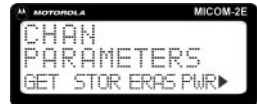

4. Press the function key that appears below the power level of your choice: Low, Med(ium), High, Max(imum).



5. Press **ENTER** to confirm, **P** to cancel.

Setting the Frequency

MICOM-2E offers four frequency options:

- *Simplex Frequency (SMPX)* - transmits and receives on the same frequency.
- *Duplex Frequency (DPLX)* - transmits on one frequency and receives on a different frequency.
- *Receiving Only Frequency (RXO)* - defines a frequency for reception only.
- *Transmitting Only Frequency (TXO)* - defines a frequency for transmission only.

To set a channel's frequency:

1. Enter the Radio Programming menu (steps 1-4 on page 29).



2. Press **F1** [CHAN].



3. Press **MORE** to scroll to the FREQ option.



4. Press **F1** [FREQ].



5. Press the function key beneath the frequency option of your choice.

6. Enter the frequency of your choice with the keypad.



7. Press **ENT** twice to confirm, **ESC** to cancel.

Choosing the Band Type

MICOM-2E has two band types:

- USB - upper side band
- LSB - lower side band

To set the channel band:

1. Enter the Radio Programming menu (steps 1-4 on page 29).



2. Press **F1** [CHAN].



3. Press **MORE** to scroll to the BAND option.



4. Press **F2** [BAND].



5. Press the function key beneath the band option of your choice.

6. Press **ENT** to confirm, **P^ES** to cancel.

Setting the Operating Mode

MICOM-2E offers three operating mode options:

- SSB - single side band
- AME - amplitude modification equivalent
- PLT - pilot mode

To set the operating mode:

1. Enter the Radio Programming menu (steps 1-4 on page 29).



2. Press **F1** [CHAN].



3. Press **MORE** to scroll to the MODE option.



4. Press **F3** [MODE].



5. Press the function key beneath the mode of your choice.

6. Press **ENT** to confirm, **ESC** to cancel.

Using Automatic Gain Control (AGC)

MICOM-2E offers two AGC speeds: SLOW and FAST.

To set the AGC speed:

1. Enter the Radio Programming menu (steps 1-4 on page 29).



2. Press **F1** [CHAN].



3. Press **MORE** to scroll to the AGC option.



4. Press **F4** [AGC].



5. Press the function key beneath the AGC speed of your choice.

6. Press **ENTER** to confirm, **ESC** to cancel.

Setting the Band Width

MICOM-2E offers four band width options:

- 2700
- 3300
- LSM - Low Speed Modem
- CW - Continuous Wave

To set the channel band width:

1. Enter the Radio Programming menu (steps 1-4 on page 29).



2. Press **F1** [CHAN].



3. Press **MORE** twice to scroll to the BW option.



4. Press **F1** [BW].



5. Press the function key beneath the band width of your choice.

6. Press **ENT** to confirm, **ESC** to cancel.

Setting Radio Parameters

Baud Rate (BAUD)

MICOM-2E offers four baud rate options:

- 1.2 - 1200 bps
- 2.4 - 2400 bps
- 4.8 - 4800 bps
- 9.6 - 9600 bps

To set the baud rate:

1. Enter the Radio Programming menu (steps 1-4 on page 29).



2. Press **F2** [PRMT].



3. Press **F1** [BAUD].

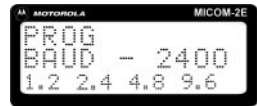

4. Press the function key beneath the baud rate of your choice:

1.2 = BAUD - 1200

2.4 = BAUD - 2400

4.8 = BAUD - 4800

9.6 = BAUD - 9600

5. Press **ENT** to confirm, **ESC** to cancel.

Data Power (DPWR)

MICOM-2E offers four data power levels:

- LOW
- MED
- HIGH
- MAX

To set the data power level:

1. Enter the Radio Programming menu (steps 1-4 on page 29).



2. Press **F2** [PRMT], Radio Parameters.



3. Press **F2** [DPWR], Data Power.



4. Press the function key beneath the DT power level of your choice.



5. Press **ENT** to confirm, **P** to cancel.

Microphone Side Tone (MST)

This menu toggles between enabling and disabling the microphone sidetone.

Press **F1** [YES] to enable the microphone sidetone.

Press **F2** [NO] to disable the microphone sidetone.

Press  to confirm, **P** to cancel.





Accessory Side Tone (AST)

This menu toggles between enabling and disabling the accessory side tone.

Press **F1** [YES] to enable the accessory sidetone.

Press **F2** [NO] to disable the accessory sidetone.

Press  to confirm, **P** to cancel.





PTT Release Beep (PTBP)

This menu toggles between enabling and disabling the beep for the push-to-talk (PTT) button.

Press **F1** [YES] to enable the beep.

Press **F2** [NO] to disable the beep.

Press  to confirm, **P** to cancel.



Keyboard Beep (KBBP)

This menu toggles between enabling and disabling the beep for the keyboard (keypad).

Press **F1** [YES] to enable the keypad beep.

Press **F2** [NO] to disable the keypad beep.

Press **ENT** to confirm, **ESC** to cancel.



Tone

This menu sets the keyboard beep tone to high or low volume.

Press **F1** [YES] to set to low volume.

Press **F2** [NO] to set to high volume.

Press **ENT** to confirm, **ESC** to cancel.



Alternate Display Time-out (ADT)

This menu sets the time-out time of the menu display. You define the number of seconds that elapse before the display returns to the previous screen.

To set the time-out time:

1. Enter the Radio Programming menu (steps 1-4 on page 29).
2. Press **F2** [PRMT].
3. Press **MORE** to scroll to the ADT option.
4. Press **F4** [ADT].
5. Press **F2** [←] to decrement the displayed value by 1.
 Press **F3** [→] to increment the displayed value by 1.
 Press **F1** [1], to quick-set the value to 1.
 Press **F4** [10], to quick-set the value to 10.
6. Press **ENT** to confirm, **P_{ESC}** to cancel.

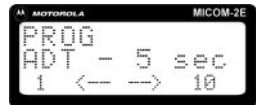

Setting Radio Options

MICOM-2E offers three programmable radio options:

- Tuner (TUNE)
- Accessory (ACC)
- ALE

To set the radio option:

1. Enter the Radio Programming menu (steps 1-4 on page 29).



2. Press **F3** [OPTS].



3. Press the function key beneath the option of your choice:

TUNE - toggles the tuner.



ACC - sets the accessory setting.



ALE - toggles ALE option on/off.

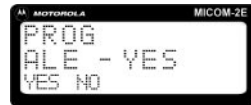

4. Press **ENT** to confirm, **P** to cancel.

Programming the Radio

MICOM-2E is already configured for use at the time of purchase. However, at times, it is necessary to change the configuration. The following sections relate to MICOM-2E's Programming mode.

You can find your radio parameter and change it by pressing a function key under the parameter name, or you can press → the scroll arrow keys to scroll through the parameters.

To enter Programming mode:

1. Press **MENU** to display the Menu screen.
2. Press **MORE** to scroll to the second Menu screen.
3. Press **F2** [PROG] to enter Program mode.
4. Press **F1** [RAD] to enter Radio Programming mode.



In this menu, you program:

- channels
- radio parameters
- radio options

The following sections explain the programming procedures in detail.

Programming Channels

When you choose the CHAN option in the Radio Programming menu, you see a menu with the following options:

- GET - Get programmed channel
- STOR - Store channel
- ERAS - Erase programmed channel
- PWR - Tx power level
- FREQ - Frequency
- BAND - Band type
- MODE - Radio mode
- AGC - Automatic Gain Control
- BW - Band width

The use of each option is explained in the following sections.

Channel Options

The first three options, GET, STOR, and ERAS, are used for programming channels in MICOM-2E.

GET retrieves channels already programmed in MICOM-2E. Once a channel is programmed in MICOM-2E, it is stored with all its parameters. Retrieving a channel retrieves all the parameters defined for the channel.

To copy a channel's parameters to another channel:

1. Enter the Radio Programming menu (steps 1-4 on page 29).



2. Press **F1** [CHAN].



3. Press **F1** [GET].



4. Enter the number of the channel to which you want to copy the parameters with the keypad.



5. Select the source channel.

6. Press **F2** [STOR].



Note that the channel number is flashing, which indicates that you can change it or leave it at the current number.

7. Enter the number of the channel to which you want to copy the parameters with the keypad.



If you need to backspace, press **F3** [BACK].

If you want to clear the display, press **F4** [CLR].

8. Press **ENT** to confirm.

To delete a channel from MICOM-2E:

1. Enter the Radio Programming menu (steps 1-4 on page 29).



2. Press **F1** [CHAN].



3. Press **F3** [ERAS].



4. Enter the number of the channel to which you want to delete.



If you need to backspace, press **F3** [BACK].

If you want to clear the display, press **F4** [CLR].

5. Press **ENT** to confirm.

Setting the Tx Power Level

Four power levels are possible for a programmed channel:

- LOW
- MED
- HIGH
- MAX

To set the channel's Tx power level:

1. Enter the Radio Programming menu (steps 1-4 on page 29).

2. Press **F1** [CHAN].



3. Press **F4** [PWR].



4. Press the function key that appears below the power level of your choice: Low, Med(ium), High, Max(imum).



5. Press **ENTER** to confirm, **P** to cancel.

Setting the Frequency

MICOM-2E offers four frequency options:

- *Simplex Frequency (SMPX)* - transmits and receives on the same frequency.
- *Duplex Frequency (DPLX)* - transmits on one frequency and receives on a different frequency.
- *Receiving Only Frequency (RXO)* - defines a frequency for reception only.
- *Transmitting Only Frequency (TXO)* - defines a frequency for transmission only.

To set a channel's frequency:

1. Enter the Radio Programming menu (steps 1-4 on page 29).



2. Press **F1** [CHAN].



3. Press **MORE** to scroll to the FREQ option.



4. Press **F1** [FREQ].



5. Press the function key beneath the frequency option of your choice.

6. Enter the frequency of your choice with the keypad.



7. Press **ENT** twice to confirm, **ESC** to cancel.

Choosing the Band Type

MICOM-2E has two band types:

- USB - upper side band
- LSB - lower side band

To set the channel band:

1. Enter the Radio Programming menu (steps 1-4 on page 29).



2. Press **F1** [CHAN].



3. Press **MORE** to scroll to the BAND option.



4. Press **F2** [BAND].



5. Press the function key beneath the band option of your choice.

6. Press **ENT** to confirm, **P^ES** to cancel.

Setting the Operating Mode

MICOM-2E offers three operating mode options:

- SSB - single side band
- AME - amplitude modification equivalent
- PLT - pilot mode

To set the operating mode:

1. Enter the Radio Programming menu (steps 1-4 on page 29).



2. Press **F1** [CHAN].



3. Press **MORE** to scroll to the MODE option.



4. Press **F3** [MODE].



5. Press the function key beneath the mode of your choice.

6. Press **ENT** to confirm, **ESC** to cancel.

Using Automatic Gain Control (AGC)

MICOM-2E offers two AGC speeds: SLOW and FAST.

To set the AGC speed:

1. Enter the Radio Programming menu (steps 1-4 on page 29).



2. Press **F1** [CHAN].



3. Press **MORE** to scroll to the AGC option.



4. Press **F4** [AGC].



5. Press the function key beneath the AGC speed of your choice.

6. Press **ENTER** to confirm, **ESC** to cancel.

Setting the Band Width

MICOM-2E offers four band width options:

- 2700
- 3300
- LSM - Low Speed Modem
- CW - Continuous Wave

To set the channel band width:

1. Enter the Radio Programming menu (steps 1-4 on page 29).



2. Press **F1** [CHAN].



3. Press **MORE** twice to scroll to the BW option.



4. Press **F1** [BW].



5. Press the function key beneath the band width of your choice.

6. Press **ENT** to confirm, **ESC** to cancel.

Setting Radio Parameters

Baud Rate (BAUD)

MICOM-2E offers four baud rate options:

- 1.2 - 1200 bps
- 2.4 - 2400 bps
- 4.8 - 4800 bps
- 9.6 - 9600 bps

To set the baud rate:

1. Enter the Radio Programming menu (steps 1-4 on page 29).



2. Press **F2** [PRMT].



3. Press **F1** [BAUD].

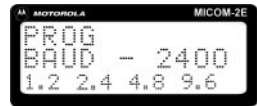

4. Press the function key beneath the baud rate of your choice:

1.2 = BAUD - 1200

2.4 = BAUD - 2400

4.8 = BAUD - 4800

9.6 = BAUD - 9600

5. Press **ENT** to confirm, **ESC** to cancel.

Data Power (DPWR)

MICOM-2E offers four data power levels:

- LOW
- MED
- HIGH
- MAX

To set the data power level:

1. Enter the Radio Programming menu (steps 1-4 on page 29).



2. Press **F2** [PRMT], Radio Parameters.



3. Press **F2** [DPWR], Data Power.



4. Press the function key beneath the DT power level of your choice.

5. Press **ENT** to confirm, **P** to cancel.

Keyboard Beep (KBBP)

This menu toggles between enabling and disabling the beep for the keyboard (keypad).

Press **F1** [YES] to enable the keypad beep.

Press **F2** [NO] to disable the keypad beep.

Press **ENT** to confirm, **ESC** to cancel.



Tone

This menu sets the keyboard beep tone to high or low volume.

Press **F1** [YES] to set to low volume.

Press **F2** [NO] to set to high volume.

Press **ENT** to confirm, **ESC** to cancel.



Alternate Display Time-out (ADT)

This menu sets the time-out time of the menu display. You define the number of seconds that elapse before the display returns to the previous screen.

To set the time-out time:

1. Enter the Radio Programming menu (steps 1-4 on page 29).
2. Press **F2** [PRMT].
3. Press **MORE** to scroll to the ADT option.
4. Press **F4** [ADT].
5. Press **F2** [←] to decrement the displayed value by 1.
 Press **F3** [→] to increment the displayed value by 1.
 Press **F1** [1], to quick-set the value to 1.
 Press **F4** [10], to quick-set the value to 10.
6. Press **ENT** to confirm, **P_{ESC}** to cancel.

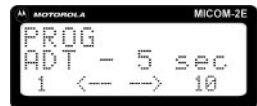

Setting Radio Options

MICOM-2E offers three programmable radio options:

- Tuner (TUNE)
- Accessory (ACC)
- ALE

To set the radio option:

1. Enter the Radio Programming menu (steps 1-4 on page 29).



2. Press **F3** [OPTS].



3. Press the function key beneath the option of your choice:

TUNE - toggles the tuner.



ACC - sets the accessory setting.



ALE - toggles ALE option on/off.

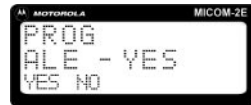

4. Press **ENT** to confirm, **P** to cancel.

Automatic Link Establishment (ALE)

The MICOM-2E unit incorporates Automatic Link Establishment (ALE) to select the best working channel from the channels programmed into the unit automatically without user intervention. The ALE incorporates all advanced data transmission techniques required by MIL-STD-188/141A and FED-STD-1045. The ALE feature thus ensures the user of the best possible link without requiring prior knowledge of radio communications.

Previously, HF radio operations had to be familiar with the constantly varying nature of the ionosphere, the atmospheric layer that reflects HF radio waves back to earth. A knowledge of the ionizing effects of sunspots, the seasons, time of day, and fluctuations in the earth's magnetic field was essential for the operator to find the best frequency for any particular link.

Manufacturers of HF-SSB equipment tried numerous methods to assist the operator in this difficult task. For example, various squelch circuits are employed to overcome operator fatigue from interference noise. Another aid is the use of several receivers so that the operator does not have to search continuously for incoming calls. More advanced are scanning receivers combining selective calling.

A more recent approach has been adopted to combine scanning with a "handshake" to establish a link. However, because the first link is not always the best, some manufacturers use Link Quality Analysis (LQA), which measures a few propagation parameters, such as the bit error rate (BER) and S/N. If the result is below a desired threshold, the search continues until a reasonable link is found. Here again, there is no guarantee that a better channel was not overlooked. Motorola's ALE, a technological breakthrough in HF-SSB communication, combines scanning, selective calling, sounding, channel selection, and LQA. These features, all automatic, ensure that even with an unskilled operator, communication takes place on the channel with the best link quality.

Activating/Deactivating the ALE

The MICOM-2E implements Automatic Link Establishment (ALE) that selects the best working channel from the available channels that are programmed for use. Using ALE is highly recommended for users because it ensures the best link possible without an in-depth knowledge of radio communications. Pages 45-51 describe the ALE features in greater detail.

To disable ALE:

1. Press **MENU** to obtain the Menu display.
2. Press **MORE** to obtain the menu with the PROG option.
3. Press **F2** [PROG].
4. Press **F1** [RAD].
5. Press **F3**, [OPTS] to enter Radio Programming mode.
6. Press **F3** [ALE].
7. Press **F2** [NO] to disable ALE.
8. Press **ENTR** to confirm.

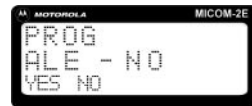
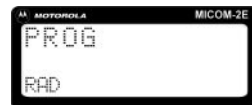
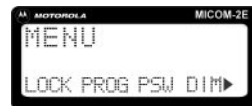

To enable ALE (after disabling):

1. Press **MENU** to obtain the Menu display.



2. Press **MORE** to obtain the menu with the PROG option.



3. Press **F2** [PROG].

4. Press **F1** [RAD].



5. Press **F3** [OPTS] to enter Radio Programming mode.



6. Press **F3** [ALE].



7. Press **F1** [YES] to enable ALE.

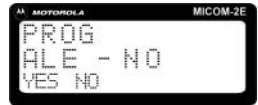

8. Press **ENTR** to confirm.

LQA Memory

The ALE builds a database of connectivity information based on calls and digital ALE “sounding” messages transmitted by other stations in the network. This information is stored in a special “LQA memory” and used to determine the link quality of all channels in the networks. The data in LQA memory is “time-weighted”, that is, recent information is given more value than old, thus compensating for changing propagation conditions.

Automatic Sounding

Automatic sounding is a method for testing the selected channels and the propagation path under field conditions. The sounding signal is a very short (beacon-like), unilateral identifying broadcast, carried out in periodic intervals on unoccupied channels.

Identifying the sounding signal sent from a station indicates a high probability of bilateral connectivity.

Long or short sounding cycles are mainly determined according to propagation conditions. In case of slow propagation changes, long intervals of about 1 or 2 hours may be sufficient. If, however, the propagation changes are erratic and rapidly changing, or if the connectivity information is critical, then shorter intervals are recommended. Each station may also measure BER and S/N, and update the LQA table accordingly.

NOTE

The maximum score for receiving an optimum sounding is 70%; the minimum score is 30%. The score given to a station that did not send any sounding or a station whose sounding has not been received is also 30%.

Sounding Cycle Time

The sounding messages is repeated at regular intervals on all channels in the network. A complete round of sounding messages, or “sounding cycle,” can be programmed to 30, 60, 90, or 120 minutes when the automatic sounding is on. The sounding can be initiated manually when there is a specific need for it, even if the system is set to operate in the automatic mode.

To select the best sounding cycle time, the trade-offs must be considered. On the one hand, a shorter cycle ensures a more updated LQA memory; thus the channel with the highest LQA value will, in fact, have the best link quality at that point in time. On the other hand, a shorter sounding cycle increases network occupancy due to more frequent sounding messages, leaving less channel-free time for the users.

Figure 1 shows network occupancy in relation to sounding cycles of 30, 60, 90, and 120 minutes. (Note that both axes have logarithmic scales.) The chart also shows 80% and 95% occupancy in a 120-minute sounding cycle at a very rapid scanning rate (applicable only to multiple-channel networks).

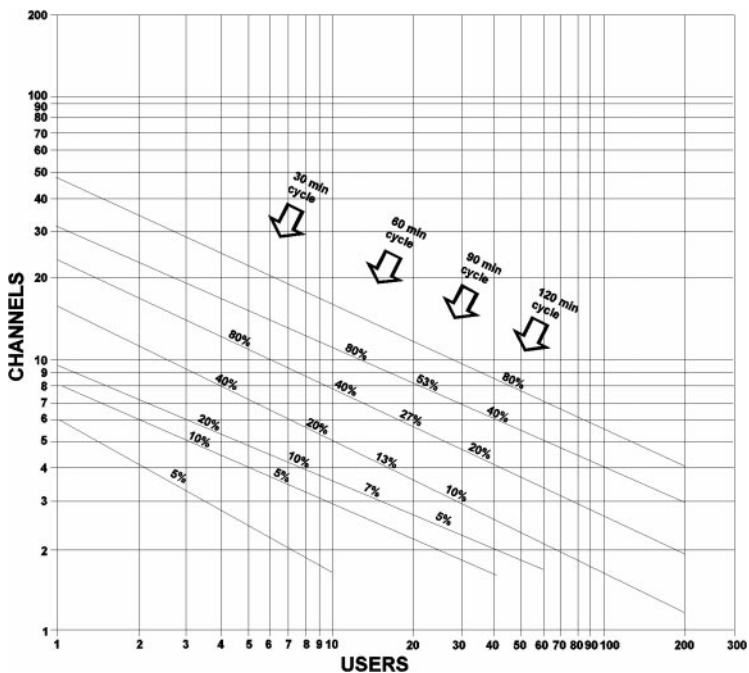

Figure 1: Network Occupancy

It is clear from the chart that if there are two or three channels in the network, a sounding cycle of 30 minutes allows enough channel-free time, even for as many as ten users. The best way of using this chart is given in the following example: in a network of nine channels used by eight members, a 30-minute sounding cycle would result in 80%

occupancy. A 60-minute cycle would result in 40% occupancy. A 90-minute cycle would result in 27% occupancy. A 120-minute cycle would result in 20% occupancy.

It can now be decided which sounding cycle is the best for any particular network, taking into account the trade-offs described above.

Under field conditions, the occupancy will usually be less than the value obtained from the chart because not every station receives all the soundings that are being broadcast on all channels. However, if the system manager wants to increase channel-free time for the users by reducing network occupancy, it is possible to do so through four methods, listed below in their order of preference:

1. Increasing the sounding cycle time (to 90 or 120 minutes).
2. Reducing the number of channels in the network (for example, by using different nets for different times of day).
3. Reducing the number of stations in the network by re-arranging the hierarchical subgrouping of stations.
4. Requesting all stations to set the fast scan rate option.

Immediate (Manual) Sounding

If it is required to perform a rapid sounding cycle on all channels instead of, or in addition to, the automatic sounding cycle, the Immediate Sounding procedure can be used.

Optional Handshake/Call Reject

The "optional handshake" is programmable. If selected, each time a sounding transmission is completed, the radio will listen for two seconds. If a call is received on the same channel, the radio will respond and establish a link.

Bi-directional Handshake

The bi-directional handshake is a shortcut procedure to exchange LQA scores with other stations in the system without establishing a link. This procedure is useful in the following cases:

- The radio has only recently been switched on and an automatic sounding cycle has not been completed yet.
- The operator wishes to update the LQA scores before initiating a call to another station.
- When a new or passive station joins to the system.
- In case of sudden atmospheric changes, etc.

The bi-directional handshake can be carried out either with a single station or with all stations in the net; it can be carried out either on a single channel or on all network channels. An AMD message can also be added to the procedure.

At the end of the bi-directional procedure with a private station, the LQA matrix is updated. The operator can then initiate a call and obtain the best channel automatically. When the bi-directional procedure is performed with a net, *all* stations in the net update their LQA tables.

ALE Programming

Motorola's Mobile ALE is highly flexible. Its functions are programmed from an external computer using the ALE Radio Service Software (RSS) program. Refer to Motorola publication no. 68P02952C25.

Receiving Calls

MICOM-2E receives four kinds of calls:

- AllCalls
- Individual calls
- Net calls
- Sound calls

Receiving an AllCall

An *AllCall* is a broadcast message. MICOM-2E uses it to establish a connection with all other stations.

1. When an AllCall is received, the display flashes an AllCall alert that alternates the words "ALL CALL" with the calling station's name.
2. Press any key, including PTT. The calling station's name appears fixed.
3. If the calling station's name is longer than 15 characters, a right arrow appears in the display.

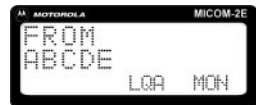

Press **F2** [-->] under the arrow to scroll the name to the right.

If only you received the call in ALE mode, the **F3** [LQA] appears for viewing the channel link quality.

4. Press **P** to disconnect the AllCall.

Disconnecting returns MICOM-2E to ALE or Channel mode, depending on which mode was active when the AllCall was received.

Receiving an Individual Call

An *individual call* is a call directed to a specific station.

1. When MICOM-2E receives an individual call, the calling station's name appears flashing in the LCD display.
2. Press any key, including PTT. The calling station's name appears fixed.
3. If the calling station's name is longer than 15 characters, a right arrow appears in the display.



Press **F2** [-->] under the arrow to scroll the name to the right.

4. Press **P** to disconnect the call.



Disconnecting returns MICOM-2E to Scan or Channel mode, depending on which mode was active when the individual call was received.

Receiving a Net Call

A *net call* is a call directed to a group of stations on the net.

1. When MICOM-2E receives a net call, the display flashes an alert that alternates the words "NET CALL" with the calling network's name.



2. Press any key, including PTT. The calling network's name appears fixed.



3. If the calling network's name is longer than 15 characters, a right arrow appears in the display.



If only you received the call in ALE mode, the **F3** [LQA] appears for viewing the channel link quality.

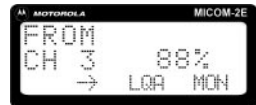

Press **F2** [-->] to scroll the name to the right.

4. Press **P** to disconnect the net call.

Disconnecting returns MICOM-2E to ALE or Channel mode, depending on which mode was active when the individual call was received.

Receiving a Sound Call

1. When MICOM-2E receives a sound call, the calling station's name appears in the LCD display with the letters S to identify that the call is a sound call.



The ALE, after a few seconds returns MICOM-2E automatically to ALE or Channel mode, depending on which mode was active when the sounding was received.

Transmitting Calls

MICOM-2E can transmit the same kinds of calls that it can receive:

- AllCalls
- Individual calls
- Net calls
- Sound calls

Transmitting AllCalls

The AllCall feature is programmable; it is possible to set MICOM-2E to receive or ignore both outgoing (Transmit) or incoming (Receive) AllCalls. For example, it is possible that a MICOM-2E station be configured to receive AllCalls but not to be able to initiate one. At the end of an AllCall, MICOM-2E automatically returns to its previous working mode.

The most common use of AllCalls is in cases of distress. A person initiating an AllCall because of distress is more likely to want to make any available connection in the minimum period of time than to issue a call to an individual or to a select group. In some situations, it may be decided to program a MICOM-2E to ignore AllCalls to ignore calls from addresses outside of a receiver's net.

If the MICOM-2E station is set to receive AllCalls, it stops scanning when an AllCall is received.

If the MICOM-2E stations is set to issue AllCalls, when it issues an AllCall, it broadcasts a message to all the other stations. All the stations that are capable of receiving calls can receive the AllCall.

In Channel mode, the call is performed on the current channel.

In Scan mode, if an AllCall channel has been defined, then the call is performed on that channel. If no AllCall channel has been defined, the call is performed on the first scanned channel of the net.

To send an AllCall:

1. Press  and hold it down continuously for about 3 seconds.

The AllCall screen appears in the LCD display.



2. Press any key, including the PTT, to establish the link.



3. Press  to disconnect the call.



Transmitting Individual Calls

MICOM-2E can initiate an individual call while in Channel mode or ALE mode. The procedure is the same as for net calls. See the following section for the procedure.

To make an individual call:

1. Press **(F1)** [CALL].

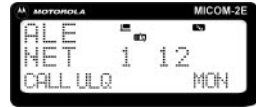

The LCD display shows the last called station.



2. Press  to scroll between the stations.

The LCD display shows the programmed network, the programmed member stations in each network, and the programmed entries into the dialing directory.

3. Choose a station or directory entry from the list.

4. Press **(F1)** [SEND].



Optionally, you can also transmit a preprogrammed message.

5. Press **(F2)** [PAGE].



6. Press **(F4)** [-->] to scroll through the message.



7. Press **(F1)** [SEND].

You can also choose to transmit over a specific channel.

8. Press **F3** [CHAN].





You see the Channel Link Quality screen in the display.



9. Press **F3** [BEST] to obtain the channel with the best broadcast LQA mark.

OR

Press  to scroll to the channel of your choice.

10. Press **F1** [SEND] or .

The horizontal bars to the right in the LCD display indicate that transmission is in progress.

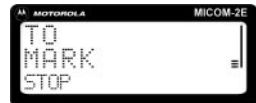

11. Press any key, including the PTT, to establish the link.



12. Press **P** to disconnect the call.



Transmitting Net Calls

The RSS, at the time of configuration, programs the group into MICOM-2E. MICOM-2E can initiate a net call while in Channel mode or ALE mode.

To make a net call:

1. Press **(F1)** [CALL].

The LCD display shows the last called station.

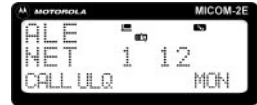

2. Press  to scroll between the stations.



The LCD display shows the programmed networks, the programmed member stations in each network, and the programmed entries into the dialing directory.

3. Choose a network from the list.
4. Press **(F1)** [SEND].

Optionally, you can also transmit a message.

5. Press **(F2)** [PAGE].



6. Press **(F4)** to scroll through the message text.



7. Press **(F1)** [SEND].



The names of the receiving stations appear in the LCD display.



8. Press any key to establish the link.



9. Press  to disconnect the call.



Link Mode

After you receive a call, the LCD display indicates that you are in Link mode.



When you transmit a call, the Link mode screen looks like this:



NOTE

All channel parameters are available in Channel mode (see page 13). Press **MORE** to view the parameters.

Using the Caller Stack

The *caller stack* stores information about unanswered calls. The stack entry contains the self address of the calling station and automatic message display (AMD).

MICOM-2E records an address in the stack only once even if the caller makes repeated unanswered calls.

The appearance of the word PAGE over the **F3** button in the LCD display indicates that there is a call present in the stack.

The stack is arranged in FIFO order, that is, the first address that enters the stack is also the first that you see on the display.

The stack icon blinks when at least one call address is registered in the stack. When you display the first unseen calling address on the stack, the stack icon appears. The icon is automatically turned off after all the pages in the stack have been erased.

To search the stack for calls:

1. Press **F3** [PAGE].

The LCD display shows:

1. the page number
2. the name of the calling station
3. a text message, if transmitted.



2. Press **F3** [**<--**] under the left arrow to scroll the message in the display to the left.

Press **F4** [**-->**] under the right arrow to scroll the message in the display to the right.

3. Press  to scroll if there are additional calls in the stack.

MICOM-2E removes an address from the stack:

- When an operator returns a call to a station registered in the caller stack, the corresponding address is erased from the stack.

- When the stack is full and a new address comes in. The stack stores up to ten addresses. The eleventh call pushes the oldest address out of the stack.
- When an address in stack is erased from the radio panel.

To return a call to a station registered in the stack:

1. Press **F1** [CALL].



2. Press **F1** [SEND].

The page in the stack is deleted automatically. The process from this point onward is like a regular call process.

To delete a page from the stack manually:

1. Press **F2** [ERAS].



MICOM-2E asks you to confirm your intentions.

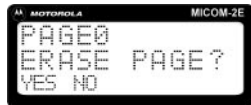

2. Press **F1** [YES] to delete the page, **F2** [NO] to cancel the deletion.

Monitoring the Speaker

In Channel or ALE Scan mode, you can toggle the speaker on and off. The word MON that appears in the LCD display indicates when it is possible to change the speaker setting.

To toggle the speaker setting:

1. Press **F4** [MON].

The LCD display indicates that the monitor setting has been changed.

2. Press **F4** [MON] again to toggle back.



Tuning the Antenna Tuner

If the antenna system is equipped with an automatic antenna tuner and the tuner is enabled, the radio will automatically tune the antenna tuner after each channel selection. Configuring the radio to work with an automatic tuner is performed via the RSS or the front panel.

Installation

General

This section describes the installation of the radio in a mobile or fixed station configuration.

The following paragraphs contain general installation procedures for both types of configuration.

Government Regulations

Read carefully the Licensing and Safety Information given in the front matter of this manual. Be sure that all your radio operation complies with these guidelines.

Inspection

Carefully inspect the radio immediately upon receipt, and notify the shipper of any damage incurred in transit.

Radio Installation Planning

Select the mounting location for convenience of access to electrical connections and for maintenance. The selected location should be clean, dry and well ventilated. Do not mount the unit in close proximity to strong electrical fields produced by brush motors and generators, welders, etc.

The antenna, antenna tuner and associated cable kits are provided separately. These should be installed before the radio is installed. Follow the instructions included with the units and kits.

The radio may be placed on any sturdy, flat surface. An accessory mounting tray (included in the Mobile Mounting Kit, FLN2272) allows the radio to be mounted in any position.

Before installing the radio, read the entire installation procedure detailed in this section. Follow the instructions carefully.

No preliminary internal wiring connections are required before installing the radio.

Base Station Installation

In fixed station installation, an AC power supply is used instead of the 12 V battery. (It is possible to connect a backup battery to the battery terminals on the power supply.) One power supply model is available:

- F2369 for 220 V AC, 50 Hz, field programmable for 110 VAC, 60 Hz.

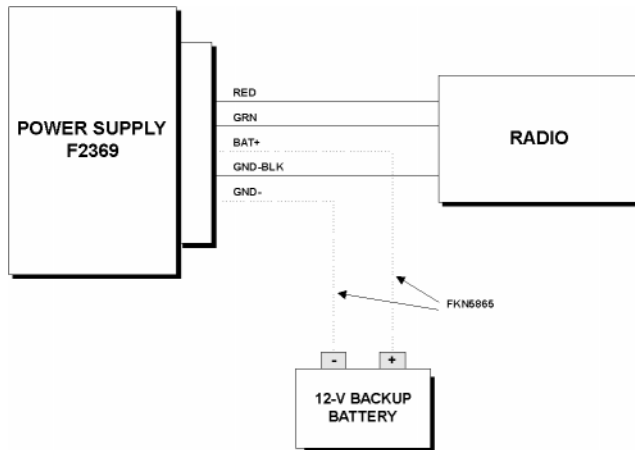

Figure 2: Power Supply

This power supply also serves as a charger for the external backup 12-V battery, if connected. When AC power failure occurs, the battery functions as the main power source. When AC power is again available, the power supply charges the battery.

The cable and connector supplied with the power supply enable connecting the supply directly to DC connector J4 at the radio rear panel. (The DC Power Cable supplied with the radio is not used in this installation.)

Front Model Installation

The diagram in Figure 3 illustrates the installation procedure for the front model of MICOM-2E.

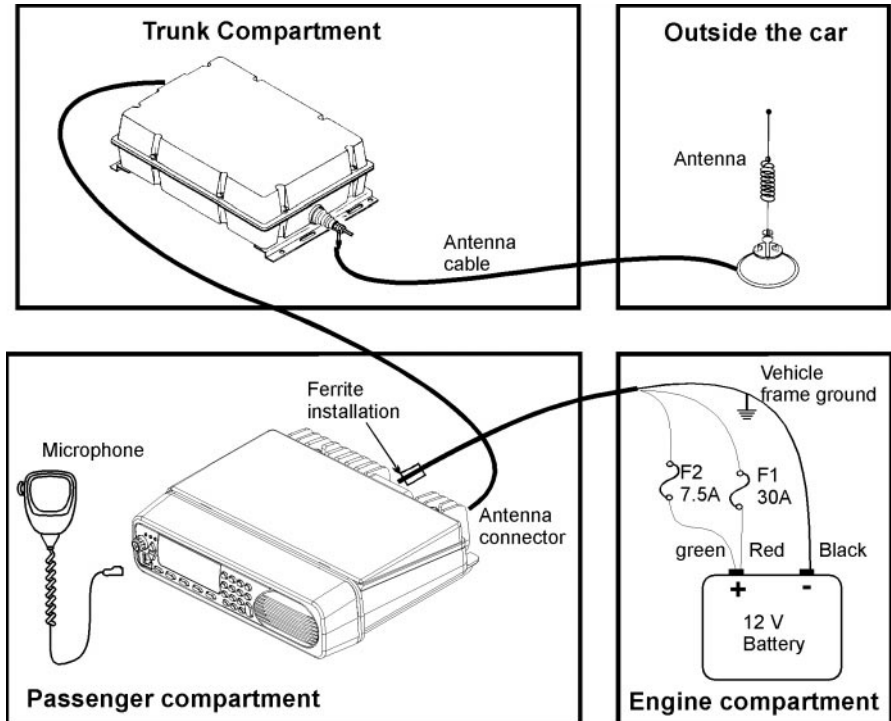

Figure 3: Front Model Installation Diagram

Figure 4 shows the location of the installed components within the vehicle.

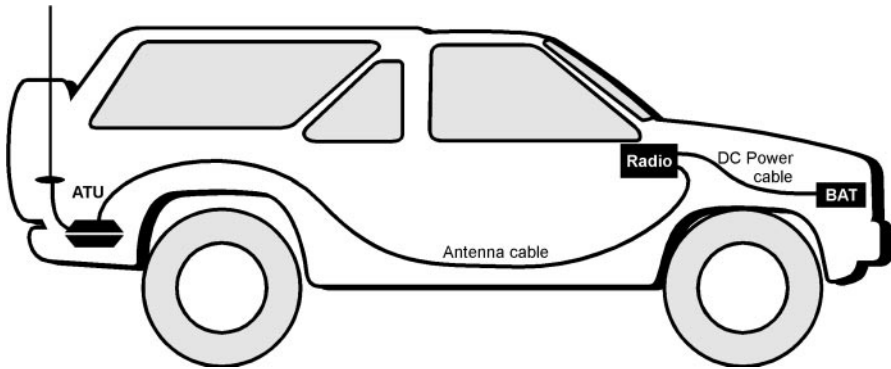

Figure 4: Front MICOM-2E Installation Within Vehicle

The radio is installed on the dashboard of the vehicle inside the passenger compartment. The other components connect to the power source, the battery, and to the antenna, which enables the radio to transmit and receive. If the battery is located in the rear section of the vehicle, the power cable extends to the battery location in the rear.

Trunk Model Installation

In the trunk model of MICOM-2E, only the control head, the speaker, and the microphone are installed in the passenger compartment of the vehicle. The radio transceiver is installed in the trunk of the vehicle together with the antenna tuner. The diagram in Figure 5 illustrates the installation procedure for the trunk model of MICOM-2E.

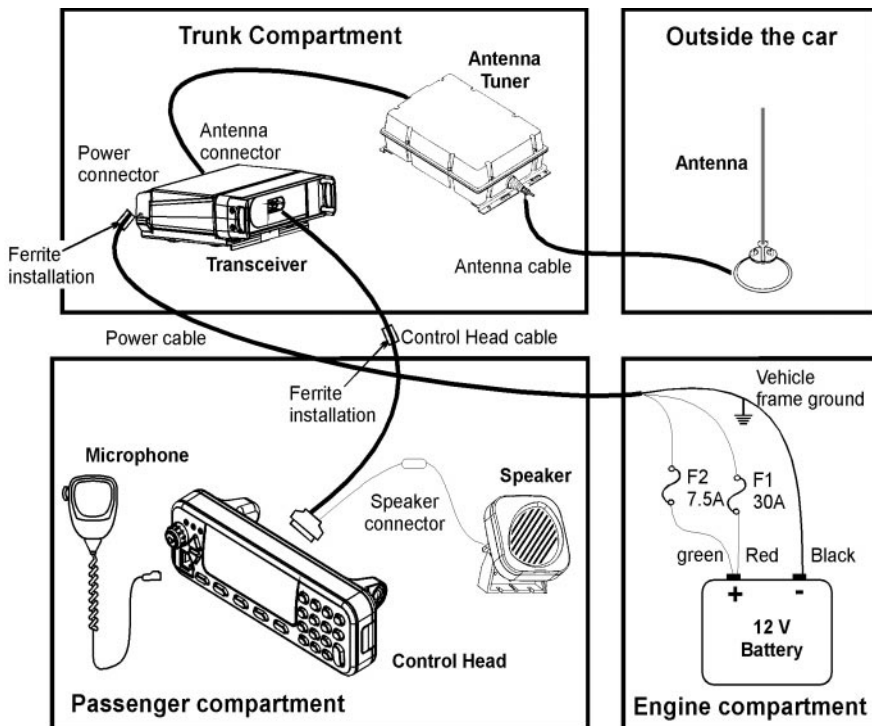

Figure 5: Trunk Model Installation Diagram

Figure 6 shows the location of the installed components within the vehicle.

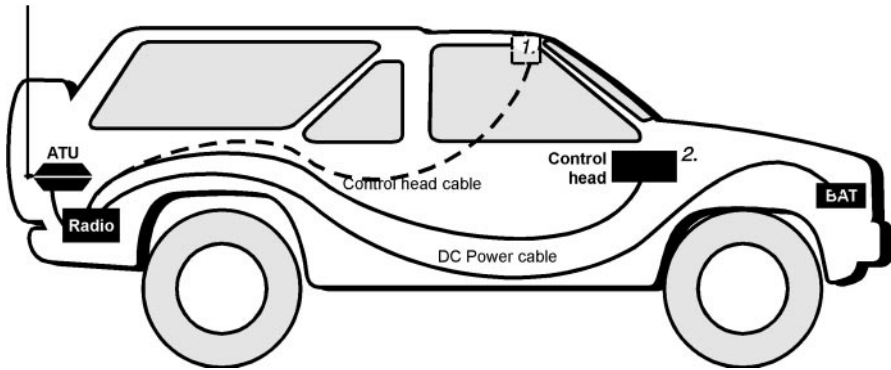

Figure 6: Trunk MICOM-2E Installation Within Vehicle

The MICOM-2E trunk model requires the connection of two cables across the length of the vehicle because the radio transceiver is located in the trunk. If the battery is located in the rear section of the vehicle, the power cable extends to the battery location.

NOTE

The upper installation (number 1 in Figure 6), is recommended over the front installation (number 2 in Figure 6) because of the covering that protects the control head from direct sunlight.

Installation Procedures

Follow these procedures to install the radio in the desired location. If the accessory mounting tray is not used, ignore the steps pertaining to it.

Mobile Mounting Kit

Step 1. Mount the accessory mounting tray in the desired location. Use the tray as a template if holes must be drilled.

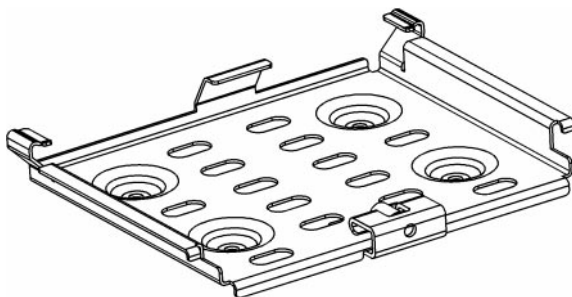

Figure 7: Accessory Mounting Tray

Step 2. Use the four supplied screws to fasten the mounting tray bracket to the bottom of the radio housing.

Step 3. Drill an additional hole for the ground bolt.

DC Power Connection

This paragraph describes connections to a 12-V negative-ground vehicular battery.

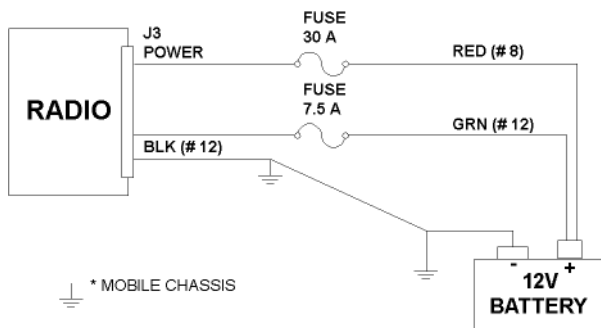

Figure 8: DC Power Connection

- Step 1.* Bring the power connector on the DC Power Cable to the radio DC connector but do not attach it to the radio. Then bring the three heavy wires (RED, GRN, BLK) to a 12-V battery, passing them through access holes as required.

NOTE

The wires must be as short as possible. They should be cut down to a minimum as required.

- Step 2.* Thread the ends of the red and green wires from the power connector through the two fuse holder caps. Cut apart the two fuse clips and solder or crimp them to the wires.
- Step 3.* Install the 30-A fuse in the fuse holder on the red wire, and the 7.5 A fuse in the fuse holder on the green wire. Then assemble the fuse holders.
- Step 4.* Crimp or solder the supplied lugs to the red, green, and black wires.
- Step 5.* Connect the lugs on the red and green cables together to the positive terminal of the battery. Then connect the lug on the black wire to the negative terminal of the battery.

NOTE

1. It is recommended to attach the black (ground) wire to the vehicle's chassis. The point of attachment should be located as close as possible to the radio. Refer to Figure 9.
 2. In front installation, add one ferrite (supplied with the installation radio kit) on the DC cable as close as possible to the radio.
 3. In trunk mount installation, add one ferrite (supplied with the installation radio kit) on the DC cable as close as possible to the radio and one ferrite on the control cable between the control head and the radio.
-

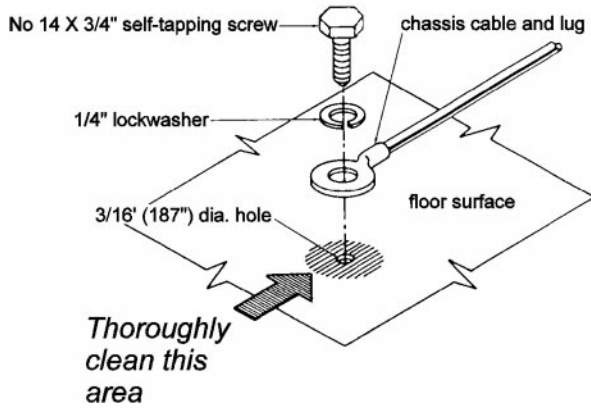

Figure 9: Wire Attachment to Chassis

Microphone Clip

The microphone cable enables placing the microphone clip in any convenient location up to five feet from the radio. To install the clip, use it as a template to drill two holes to receive self-threading sheet-metal screws. Mount the clip using the supplied screws.

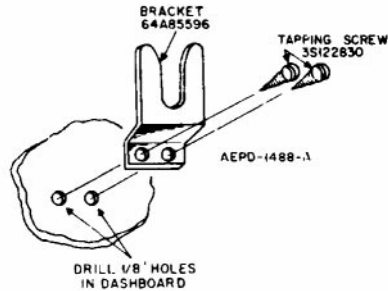

Figure 10: Microphone Clip

Final Connections

- Step 1.** Ensure that the radio is off. Then connect the power cable to DC connector J4 and connect the antenna RF cable to antenna connector J2.
If an antenna tuner is used, connect the antenna to the tuner, connect the tuner RF cable to connector J3, located on the radio rear panel.
- Step 2.** If the mounting tray is used, slide the radio into the tray and fasten the tray bracket with the supplied screw.

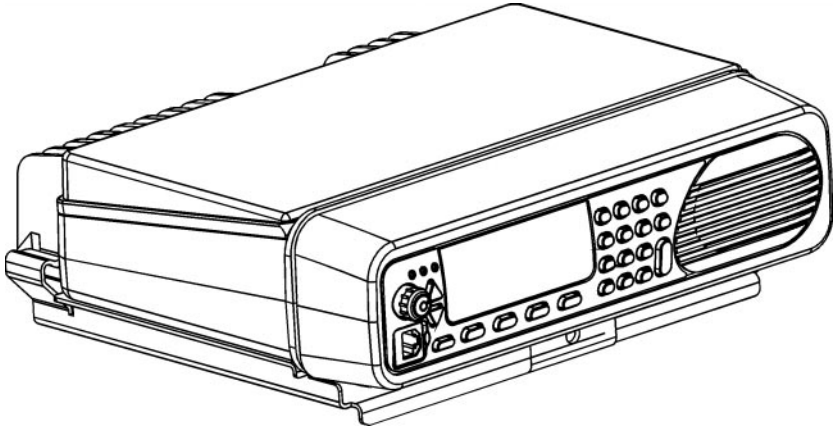

Figure 11: Fitting Radio onto Mounting Tray

- Step 3.* Use the tie straps included with Cable Kit to tie loose cables out of the way.
- Step 4.* Connect a ground lead from the GND screw on the radio rear panel to the mobile chassis.

IMPORTANT

Special attention should be given to locating a good vehicle ground. Optimum radio performance can only be achieved with a ground connection having a very low resistance. The vehicle frame makes the best ground, but body structural reinforcement members are also suitable for grounding purposes. The ground lead should be as short as possible.

- Step 5.* If desired, plug an external speaker into the accessory connector. Any speaker with an impedance greater than 8 ohms can be used.

External Speaker Installation

Connect the external 8 Ohms, 5 Watts speaker to the accessory connector (pin 1,3). The external speaker is connected in parallel to the internal speaker.

If disconnection of the internal speaker is required, perform the following steps:

- Step 1.* Insert a small, flat-blade screwdriver in the slotted area on the right hand-side panel of the radio and press the screwdriver towards you, to release the Control Head.

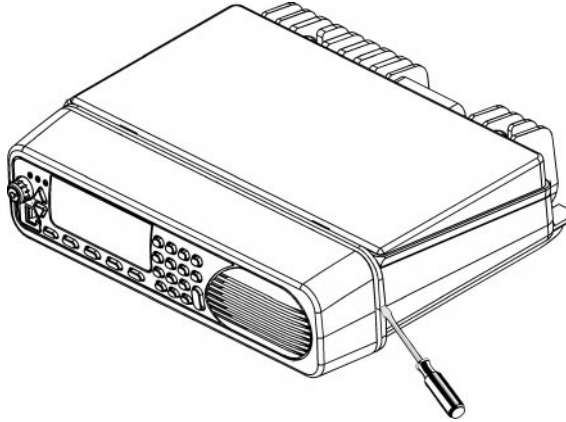

Figure 12: Opening the Control Head

- Step 2.* Disconnect the internal speaker from the board.
- Step 3.* Return the top cover to its original position by applying pressure on both sides of the cover. Observe that the seal is correctly located.

Operational Checks

When installation is complete, carefully check all operating functions (refer to the Operation section). In case of malfunctioning, refer to Troubleshooting and Tuning the Antenna paragraphs in this manual.

Connectors

Microphone Connector J1

The microphone connector is located on the lower part of the radio front panel. Table 1 lists the functions of the microphone connector pins.

Table 1. Connector J1, Pin Connections

Pin No.	Pin Name	Description
1	SWA+	Line used to power up the microphone
2	RXD	Serial communication line
3	TXD	Serial communication line
4	GND	Ground line
5	MIC AUDIO	Input audio signals generated by the microphone (600 Ohms impedance, 100 mV 1 KHz tone is required for full output power).
6	PTT MIC	Activates transmission by short to ground.
7	MONITOR	Line which mutes the speaker before transmission is enabled (short momentary to ground to open speaker).
8	AUDIO OUT	Receive audio 600 Ohms (300 mVRMS)

Antenna Connector J2

The “N type” antenna connector is located on the rear panel of the transceiver. In transmit mode, it is used to feed the antenna with the transmit power; and in receive mode it is used to deliver the received signal from the antenna to the radio.

Accessory Connector J3

The accessory connector J3 is located on the radio rear panel. It is intended for use with external accessories such as: modem, linear amplifier, phone patch, etc.

The user can use the 25-pin D-type plug to make his own required connections or he can use the Interface cable FKN4403 (same as S809 option) when Morse key and headphones are needed to be connected by their standard connectors. Also, the user can utilize FLN2271 if he needs to connect up to four devices. Table 2 lists Connector J3, Pin Connections.

Table 2. Connector J3, Pin Connections

Pin No.	Pin Name	Description
1	SPKR-	Differential output to the external 8Ω, 8W speaker.
2	SPARE	
3	SPKR+	Differential output to the external 8Ω, 8W speaker.
4	RX AUDIO+	Differential output received audio signals (0 dBm; 600Ω; not controlled by volume).
5	RX AUDIO-*	Differential output received audio signals (0 dBm; 600Ω; not controlled by volume).
6	TX AUDIO+	Differential input received audio signals (600Ω input impedance, 0 dBm is required for full power).
7	TX AUDIO-*	Differential input received audio signals (600Ω input impedance, 0 dBm is required for full power).
8	PTT_IN VOICE	Transmission command (by short to ground) for voice signals.
9	PTT_IN DATA	Transmission command (by short to ground) for data signals.
10	PTT_IN CW	Transmission command (by short to ground) for CW (Morse) signals.
11	SWA+	13.8V (nominal) current limited.
12	KW_C_C	KW option channel change
13	KW_ON/OFF	KW option power ON/OFF.
14	AGC FAST/SLOW	AGC fast or slow release.
15	RXD	Point to point communication line to HOST/HLC.
16	TXD	Point to point communication line to HOST/HLC.
17	RESET	External RESET.
18	GND	Ground
19	KW PTT	KW PTT
20	EXT_ALARM	External Alarm Operation (open collector -pulled to ground when external alarm is activated.
21	VPP	Flash programming voltage
22	KW_ALC	KW_ALC
23	SQ_GATE	Squelch Indication
24	FAN ON/OFF	FAN ON/OFF
25	KW TUNE	KW tune

* Do not connect to GND.

DC Connector J4

The DC connector J4 is mounted on the rear panel of the radio. It is used to feed the radio with the required power from AC power supply or from the battery. The following table lists the function of the DC connector lines.

Table 3. Connector J4, Pin Connections

Pin No.	Pin Name	Description
1	TX POWER	Used to deliver high currents to the radio up to 28 Amp, mainly for the transmitter circuitry
2	Ground	Used as return line for receive and transmit lines
3	RX Power	Used to deliver relatively low currents to the radio up to 3 Amp, mainly for the receiver circuitry

Vehicular Noise Reduction

Most vehicles are subject to several noise sources which greatly disturb a received signal. The most noisy sources are the high voltage ignition sparks that are produced at the vehicle's plugs. The second is the alternator activity.

In keeping with the following insulation practices and if necessary by adding some damping components, it may be possible to reduce these noises to a tolerable level.

1. Keep your antenna tuner and antenna as far as possible from the engine compartment.
2. Connect the primary power lead of the radio directly to the battery instead of the starter relay. The battery acts as a large capacitor (about one farad for 50 Amp capacity batteries) by passing the noise to ground.
3. If necessary, connect 0.01 - 0.1 micro farad capacitors across the primary leads of the coil and across the alternator output.
4. Keep your DC and RF cables as short as possible.
5. If your vehicle does not have a resistive ignition wire, it is recommended to replace it with a such a wire.
6. The MOTOROLA RF noise reduction kit for alternator equipped vehicles (TLN8845) includes some useful accessories for noise reduction. Among them being the resistive ignition coil suppresser cable. In severe noise conditions, you may find this kit helpful.

Maintenance

Introduction

This section provides maintenance information for the user of the MICOM-2E Radio. By carrying out the installation procedures correctly and following the maintenance instructions properly, you ensure continual operation of your radio set.

Built-In-Test Equipment (BITE)

When an internal problem appears or is suspected, the MICOM-2E internal BITE will assist the user to locate the source of this possible problem and inform the service shop or dealer accordingly.

Preventive Maintenance

System Integrity

Periodically check the integrity of your system, check the power source, cables, coaxes, connectors, antenna tuner (if exists) and antenna. Carefully check that no damage has been caused to your cables, pay extra attention to runaway through holes and bent cables.

Periodic Calibration

To keep the frequency accuracy of your radio, it is required to calibrate its internal frequency source after the third, sixth and twelfth month, and yearly thereafter. Please ensure that your radio is calibrated on time.

Using BITE

Every time the radio is turned on, a self test procedure is being activated. If an internal malfunction is found, an error message will be displayed. Please contact your service shop or dealer and inform him about the trouble indicated by BITE. The potential errors are:

Table 4. Error Messages

Error No	Description
01	DSP boot checksum fail (download)
02	DSP PLL unlock
03	DSP external RAM memory
04	Not applicable
05	DSP internal RAM memory
06	Not applicable
07	Not applicable
08	HC16 flash memory checksum
09	HC16 RAM memory
10	No 16.8 MHz clock
11	Battery low
12	Control head wake-up
13	Control head is not responding
14	Radio not programmed
15	Database fail

Troubleshooting

In case of malfunctioning, refer to the following table:

Table 5. User Troubleshooting Chart

Problem	Troubleshooting
Blank Display	<p>CHECK</p> <ul style="list-style-type: none"> • DC power cable is connected properly to the radio and battery. • A 7.5A fuse is installed in the fuse holder located on the green wire of the DC power cable.
Display present but weak or no receive signal or noise	<p>CHECK</p> <ul style="list-style-type: none"> • Connection of antenna to antenna tuner and antenna tuner to radio cables (loose or broken connections) • Squelch position OFF. • Correct programming of operating channel (frequency, mode of operation, etc).
Engine noise picked up by the antenna	<p>Determine by observing difference in the reception by turning the Engine ON/OFF.</p> <p>ENSURE</p> <ul style="list-style-type: none"> • Ground leads are properly connected, all power wires and ground leads are as short as possible • That Noise Blanker (if installed) is enabled. • Install noise reduction Kit TLN8845.
Poor or no transmission	<p>CHECK</p> <ul style="list-style-type: none"> • That a 30A fuse is installed in the fuse holder located on the red wire of the power cable. • That proper grounding cables are connected from the radio and from the antenna tuner to the vehicle chassis. • While speaking, check RF power bars for activity. The resultant RF power output is displayed in approximately 15 W increments (bars) being added from left to right. • If three or more left-hand bars disappear, there may be a problem in the antenna system. If antenna cabling, antenna mast rigging position has changed since the antenna was last tuned, the antenna tuner will not be adjusted automatically. To retune the antenna tuner, scroll to the next channel and thereafter scroll back. If this procedure does not correct the situation, inspect the tuner, antenna and ground plane for loose connections or misplaced parts. If no loose connections are found, call the nearest Motorola technician or service facility for assistance.

Problem	Troubleshooting
Poor or no transmission (continued)	<ul style="list-style-type: none"> If bars are missing on the right side of the RF power bar graph, it indicates low transmitter power, which can be caused by a faulty microphone, faulty transmitter, overheating, or defective antenna system.

In case of a failure during operation, the following messages appear on the radio's display:

Table 6. Failure Messages

Message	Troubleshooting
NO CLOCK	CHECK <ul style="list-style-type: none"> That a 30A fuse is installed in the fuse holder located on the red wire of the power cable.
SYN FAIL	Perform a built-in test via the RSS, to obtain more information.
PW_LATCH	Perform a built-in test via the RSS, to obtain more information.
OVER TMP	CHECK <ul style="list-style-type: none"> That there is no fan obstruction. Perform a built-in test via the RSS, to obtain more information.
CU-LIMIT	CHECK <ul style="list-style-type: none"> That the radio is programmed to TUNER OFF when your antenna system is not equipped with an ATU. If a short circuit occurred in the antenna's coax. That the ATU is in working condition.
NOT PROG* (on the display)	<ul style="list-style-type: none"> The radio is not programmed and the baud rate is 1200 bit/sec. Program the radio parameters (from RSS)

*This message will appear if the radio DC power failed during the RSS programming.

Service

Proper repair and maintenance procedures will assure efficient operation and long life for this product. A Motorola maintenance agreement will provide expert service to keep this and all other communication equipment in perfect operating condition. Through its maintenance and installation program, Motorola makes available the finest service to those desiring reliable, continuous communications on a contract basis.

Motorola's Customer Service Division is the largest service organization specializing in mobile communications. It includes over 900 authorized or company-owned stations. In addition, our products are serviced throughout the world by a wide network of company or authorized independent distributor service organizations. For a contract service agreement, please contact your nearest Motorola service representative, or Motorola sales representative. If you suspect a radio problem, check the following items before requesting service.

Phone line support:

Motorola Radio Support Center
3761 S. Central Avenue
Rockford, IL 61102
USA

Phone:

International: 847-725-4830
Domestic USA: 1-800-227-6772

For customers of the US Federal Market, phone line support is available at:

Motorola USFG Depot
7940 Penn Randall Place
Upper Marlboro, MD 20772
USA

Phone:

International: 301-736-4300 (Fax: 301-735-7414)
Domestic USA: 1-800-969-6680 (Fax: 800-784-4133)

Radio Checks

- Be sure the radio is turned on.
- Replace or recharge the battery. The first time a new battery is used, it should be charged for at least 16 hours.
- The antenna must be screwed on properly, with its base flush against the top of the radio.
- Could your radio problem be caused by accessories improperly connected?
- Try operating the radio from several different locations, especially when using the radio inside buildings.

Procedures

Changing the display brightness level.....	27
Changing the frequency value in the LCD display	18
Changing the password	25
Choosing a new channel.....	15
Copying a channel's parameters to another channel	31
Deleting a channel from MICOM-2E	32
Deleting a page from the stack manually	64
Disabling ALE.....	46
Enabling ALE (after disabling)	47
Entering BITE mode	21
Entering Channel mode	13
Entering DIM mode	27
Entering Frequency mode	17
Entering Lock mode.....	22
Entering Password mode.....	24
Entering Program mode	23
Entering Programming mode	29
Entering Scan mode	20
Making a net call	60
Making an individual call.....	58
Receiving a net call	54
Receiving a sound call.....	55
Receiving an AllCall	52
Receiving an individual call.....	53
Returning a call to a station registered in the stack	64
Searching the stack for calls.....	63
Sending an AllCall	57
Setting a channel's frequency.....	34
Setting the AGC speed	37
Setting the baud rate.....	39
Setting the channel's Tx power level	33
Setting the channel band	35
Setting the channel band width	38
Setting the data power level	40
Setting the operating mode.....	36
Setting the radio option	44
Setting the time-out time	43

Toggling the speaker setting	65
Transmitting.....	26
Turning the radio on	11

Index

—A—

accessories, 2
accessory connector, 9, 79
ALE, 45
alert tone indications, 9
AllCall, 52
AMD, 63
antenna connector, 79
Automatic Link Establishment, 45
automatic message display, 63

—B—

BER, 45, 48
bi-directional handshake, 51
bit error rate, 45, 48
BITE mode, 21, 83

—C—

call reject, 50
caller stack, 63
Channel mode, 13
connectors, 79

—D—

DIM mode, 27
Dimmer mode, 27
DPLX, 19, 34
Duplex Frequency, 19, 34

—F—

Frequency mode, 17

—I—

icon indicators, 8
Immediate Sounding, 50
individual call, 53

—L—

LCD icons, 8
LED indicators, 6
Link Quality Analysis, 45
Lock mode, 22
LQA, 45
LQA memory, 48

—M—

manual sounding, 50

—N—

net call, 54

—O—

optional handshake, 50
options, 2

—P—

Password mode, 24
Program mode, 23

—R—

Receiving Only Frequency, 19, 34
RXO, 19, 34

—S—

S/N, 45, 48
Scan mode, 20
signal to noise, 45, 48
Simplex Frequency, 19, 34
SMPX, 19, 34
Sound call, receiving, 55
Sounding, automatic, 48
stack, 63

—T—

Transmit mode, 26
Transmitting Only Frequency, 19, 34
TXO, 19, 34

68P02952C60-O

